



# City of Kingsville

## Commercial Construction Pre-Development Application & Statement of Acknowledgement

Email to: [hsolis@cityofkingsville.com](mailto:hsolis@cityofkingsville.com); Ph: (361) 595-8055

**GENERAL INFORMATION**

Property Owner Name: \_\_\_\_\_ Ph #: \_\_\_\_\_

Project Name: \_\_\_\_\_ Email: \_\_\_\_\_

Project Address: \_\_\_\_\_

Zoning Classification: \_\_\_\_\_ (see GIS app via: <https://kingsvillegis.com/#/mwl>)

Is property zoned for its intended use? Yes No (If no, rezoning is required; explain process: PNZ/Commission/etc. Fill out **Tab A and B**)

Is property platted? Yes No (If no, explain process: PNZ/Commission/etc. Fill out **Tab A**)

Is property in the Historic District? Yes No (If yes, Historical Development Board (HDB) approval is required prior to issuing a permit; explain process. Fill out HDB Review Application **Tab C**)

Is property in the Floodplain? Yes No (If yes, obtain elevation certificate prior to issuing permit. Fill out **Tab D (see Engineering)**)  
(Use FEMA Flood Map Service Center website)

Contractor(s): \_\_\_\_\_ Are they licensed in the City of Kingsville? Yes No  
\_\_\_\_\_ (If no, fill out **Tab E**)

Engineer Name: \_\_\_\_\_ Ph #: \_\_\_\_\_ Email: \_\_\_\_\_

Architect Name: \_\_\_\_\_ Ph #: \_\_\_\_\_ Email: \_\_\_\_\_

**Schedule MANDATORY in-person meeting on Tuesdays at 2:30pm (Development Review Team):**

**Call (361) 595-8055 Date: \_\_\_\_\_**

**Plan Review Fee of \$ \_\_\_\_\_ collected on \_\_\_\_\_ Send to Bureau Veritas? Yes No**

Is a Special Use Permit Required? Yes No ( If yes, explain process: PNZ/Commission/etc. Fill out **Tab A and F**)

Will this project be a restaurant? Yes No (If yes, see **Tab G**. Visit Health Dept)

Will you be selling alcohol? Yes No (If yes, explain process: City Secretary/PNZ/Commission/etc.) Visit City Secretary

**Tell us about your project**

Demo? New Construction? Remodel? Addition?

Description of work to be completed:  
\_\_\_\_\_  
\_\_\_\_\_  
\_\_\_\_\_

Valuation of project: \$ \_\_\_\_\_ Project sq ft: \_\_\_\_\_

Work start date: \_\_\_\_\_ Estimated date of work completion: \_\_\_\_\_

Please consult our City of Kingsville Ordinances before starting your project: Please find the ordinances at: [https://library.municode.com/tx/kingsville/codes/code\\_of\\_ordinances](https://library.municode.com/tx/kingsville/codes/code_of_ordinances)

**\*For frequently used ordinances, see Tab U**

**Construction Plans Submittal Requirements (all plans must comply with the following codes):**

- (2024 Building Code)
- (2024 Existing Building Code)
- (2024 Property Maintenance Code)
- (2024 International Fire Code/NFPA 101)
- (2023 National Electrical Code)

**4 hard copy sets of full-size (24"x 36"), 2 hard copy sets of reduced-size\* (11"x 17") [drawn to architects and engineer's scale] + 1 electronic set (on a thumb drive, sent via email, etc.)**

\* 1 additional reduced-size set for restaurants

- a. \_\_\_\_\_ Site plan, including grading, drainage and utility plan with details + as required  
**(must be completed by a Texas Licensed Engineer)**
- b. \_\_\_\_\_ Building: floor framing & walls & ceiling framing & roofing framing
- c. \_\_\_\_\_ Plumbing
- d. \_\_\_\_\_ Electrical
- e. \_\_\_\_\_ Mechanical
- f. \_\_\_\_\_ Gas
- g. \_\_\_\_\_ Fire prevention
- h. \_\_\_\_\_ Foundation
- i. \_\_\_\_\_ Signs
- j. \_\_\_\_\_ Landscaping
- k. \_\_\_\_\_ Elevation - all sides
- l. \_\_\_\_\_ (Texas Accessibility Standards)TAS
- m. \_\_\_\_\_ Texas Department of Insurance (TDI) Requirements/Windstorm Certification
- n. \_\_\_\_\_ Asbestos Survey (as required)
- o. \_\_\_\_\_ Elevation Certificate
- p. \_\_\_\_\_ Additional info (as req'd) : \_\_\_\_\_

**\* REQUIRED\***

Parking Plans, to include driveway(s) & sidewalk(s)

**Points of Contact:**

Permit Clerk	Mrs. Theresa Cavazos	<a href="mailto:tcavazos@cityofkingsville.com">tcavazos@cityofkingsville.com</a>	361-595-8019
Senior Planner	Mr. Kobby Agyekum	<a href="mailto:kagyekum@cityofkingsville.com">kagyekum@cityofkingsville.com</a>	361-221-6754
Building Official	Mrs. Belinda Tarver	<a href="mailto:btarver@cityofkingsville.com">btarver@cityofkingsville.com</a>	361-595-8020
Building Inspector	Vacant	TBD	361-595-8022
City Engineer	Mr. Rutilio Mora	<a href="mailto:rmora@cityofkingsville.com">rmora@cityofkingsville.com</a>	361-595-8004
Health Director	Mr. Emilio Garcia Mr.	<a href="mailto:egarcia@cityofkingsville.com">egarcia@cityofkingsville.com</a>	361-592-3324
Public Works Director	Bill Donnell	<a href="mailto:wdonnell@cityofkingsville.com">wdonnell@cityofkingsville.com</a>	361-595-8051
Fire Marshal	Mr. Steve Palacios	<a href="mailto:fmo@cityofkingsville.com">fmo@cityofkingsville.com</a>	361-221-6757
Downtown Manager	Mrs. Alicia Tijerina	<a href="mailto:atijerina@cityofkingsville.com">atijerina@cityofkingsville.com</a>	361-592-8516
Chamber of Commerce	Mr. Manny Salazar	<a href="mailto:manny@kingsville.org">manny@kingsville.org</a>	361-592-6438

***"I fully understand and acknowledge all requirements within this application"***

Owner Signature: \_\_\_\_\_ Date: \_\_\_\_\_

Owner Printed Name: \_\_\_\_\_

Director of Planning Signature: \_\_\_\_\_ Date: \_\_\_\_\_

# Commercial Building Application

## Table of Contents

Tab A.....	Master Land Use Application
Tab B.....	Application Checklist for Re-Zoning
Tab C.....	Historical Development Board Review Application
Tab D.....	Floodplain Development Permit and Application Form
Tab E.....	Contractor License Application
Tab F.....	Application Checklist for Special Use Permits
Tab G.....	Minimum Requirements for Food Establishments
Tab H.....	Commercial Permit Conditions
Tab I.....	Building Permit Application
Tab J.....	Dumpster Enclosure Details
Tab K.....	Permit Instructions and Application for Driveways/Sidewalk/Parking Lot
Tab L.....	Parking Area Dimensions
Tab M.....	Concrete Driveway & Sidewalk Details
Tab N.....	Pedestrian Facilities Curb Ramp Schematics
Tab O.....	Sample of Accepted Drawings
Tab P.....	Landscaping Policy
Tab Q.....	Permit Instructions and Application for Fences
Tab R.....	Sign and Billboard Application
Tab S.....	Inspection Information
Tab T.....	Certificate of Occupancy Application
Tab U.....	Ordinances of Interest
Tab V.....	Points of Contact



CITY OF KINGSVILLE  
PLANNING AND ZONING DIVISION  
MASTER LAND USE APPLICATION

email: [hsolis@cityofkingsville.com](mailto:hsolis@cityofkingsville.com) / Phone (361) 595-8055

**PROPERTY INFORMATION: (Please PRINT or TYPE)**

Project Address \_\_\_\_\_ Nearest Intersection \_\_\_\_\_

(Proposed) Subdivision Name \_\_\_\_\_ Lot \_\_\_\_\_ Block \_\_\_\_\_

Legal Description \_\_\_\_\_

Existing Zoning Designation \_\_\_\_\_ Future Land Use Plan Designation \_\_\_\_\_

**OWNER/APPLICANT INFORMATION: (Please PRINT or TYPE)**

Applicant/Authorized Agent \_\_\_\_\_ Phone \_\_\_\_\_

Email Address (for project correspondence only): \_\_\_\_\_

Mailing Address \_\_\_\_\_ City \_\_\_\_\_ State \_\_\_\_\_ Zip \_\_\_\_\_

Property Owner \_\_\_\_\_ Phone \_\_\_\_\_ FAX \_\_\_\_\_

Email Address (for project correspondence only): \_\_\_\_\_

Mailing Address \_\_\_\_\_ City \_\_\_\_\_ State \_\_\_\_\_ Zip \_\_\_\_\_

Select appropriate process for which approval is sought. Attach completed checklists with this application.

Annexation Request _____	No Fee	Preliminary Plat _____	Fee Varies
Administrative Appeal (ZBA) _____	\$250.00	Final Plat _____	Fee Varies
Comp. Plan Amendment Request _____	\$250.00	Minor Plat _____	\$100.00
Re-zoning Request _____	\$250	Re-plat _____	\$250.00
SUP Request/Renewal _____	\$250	Vacating Plat _____	\$50.00
Zoning Variance Request (ZBA) _____	\$250	Development Plat _____	\$100.00
PUD Request _____	\$250	Subdivision Variance Request _____	\$25.00 ea

Please provide a basic description of the proposed project:

\_\_\_\_\_  
\_\_\_\_\_  
\_\_\_\_\_

I hereby certify that I am the owner and /or duly authorized agent of the owner for the purposes of this application. I further certify that I have read and examined this application and know the same to be true and correct. If any of the information provided on this application is incorrect the permit or approval may be revoked.

Applicant's Signature \_\_\_\_\_ Date: \_\_\_\_\_

Property Owner's Signature \_\_\_\_\_ Date: \_\_\_\_\_

Accepted by: \_\_\_\_\_ Date: \_\_\_\_\_

## Application Check List for a Re-Zoning

The following must be submitted prior to the application deadline. Otherwise, the application will be deemed incomplete and may result in unnecessary delays: (Please ✓ when complete)

Site and landscape plans: 1 full size and 15 - 11"x17" reductions (copies from PMT reduction)

- \_\_\_ 1. A written description of the requested zoning district and the proposed use.
- \_\_\_ 2. A site plan showing the location, dimension, material and configuration of all existing buildings, structures and other improvements.
- \_\_\_ 3. The lot size in square feet and the dimensions thereof.
- \_\_\_ 4. The land uses surrounding the lot(s) for which site plan approval is being sought.
- \_\_\_ 5. The zoning on the lots and parcels surrounding the lot(s) for which site plan approval is being sought.
- \_\_\_ 6. Such additional information as the city planner may deem pertinent and essential to the application.

**Please note that this process can take up to 100 days.**

# *Historical Development Board Review Application*

**Applicant:** \_\_\_\_\_

Address: \_\_\_\_\_

Contact: Cell: \_\_\_\_\_ Home: \_\_\_\_\_

Email: \_\_\_\_\_

**Property Owner:** \_\_\_\_\_

Address: \_\_\_\_\_

Contact: Cell: \_\_\_\_\_ Home: \_\_\_\_\_

**Property Location and Description:** \_\_\_\_\_

\_\_\_\_\_

**Description of Work:** \_\_\_\_\_

\_\_\_\_\_

\_\_\_\_\_

**Contractor:** \_\_\_\_\_

Contact: Cell: \_\_\_\_\_ Home: \_\_\_\_\_

Email: \_\_\_\_\_

- Documents Required:**
1. Sketch, Drawing, Plans, Site Plans, Mock-ups
  2. Photographs (Historic, Current, Surrounding Structures)
  3. Materials List or Samples
  4. Proof of Ownership
  5. Letter of Representation and Work Approval from Property Owner (If Applicable)

I certify that this information and the additional information submitted to the Planning Department is correct and that the work will be completed as described, as approved by the Historical Development Board and in accordance with applicable codes.

(Applicant) Print Name: \_\_\_\_\_

Signature: \_\_\_\_\_ Date: \_\_\_\_\_

Hearing Date: \_\_\_\_\_ Approved  Disapproved with conditions  Disapproved

- Meetings are held at City Hall, Helen Kleberg Groves Community Room, 400 W King Ave.
- If the Board disapproves the application with recommended changes, the applicant has 5 days to inform the City if he/she accepts the changes.
- If the application is disapproved or if the applicant does not accept all recommendations, he/she may appeal the Boards decision by informing the City within the 5 day period.
- The Board only hears cases when the owner is present or represented.
- Call 361-595-8055 for information.



**CITY OF KINGSVILLE**  
**ENGINEERING DEPARTMENT**  
**400 WEST KING AVENUE**  
**KINGSVILLE, TX 78363**  
**PHONE:361-595-8007 Fax:361-595-8064**

OFFICE USE

Floodplain Permit Number: \_\_\_\_\_  
 Building Permit Number: \_\_\_\_\_  
 Fee Paid: \_\_\_\_\_ Receipt #: \_\_\_\_\_  
 Date Filed: \_\_\_\_\_  
 Approved:        YES        NO

**FLOODPLAIN DEVELOPMENT PERMIT  
 AND APPLICATION FORM**

OWNER AND PROPERTY INFORMATION				
Applicant/Owner name:				Phone:
Address:				Fax:
City:	State:			Zip:
Engineer/Contractor Name:				Phone:
Address:				Fax:
City:	State:	Zip:	Email:	
PROJECT INFORMATION				
Project address:				
Legal description of property:				
Proposed project: (circle one)	New structure	Addition	Remodel	Mobile home
Attached garage	Accessory structure	Fill	Excavation	Change of use
Other (describe):				
Description of development:				
SUBMITTAL REQUIREMENTS (check items included with application)				
___ Construction and material specifications		___ Location map		
___ Site plan		___ Pre-construction Elevation Certificate (for new structures)		
REMODELS AND REDEVELOPMENT ONLY				
Cost of improvement for this project: (submit itemized cost list, or projected appraised value upon completion)				
Value of structure: (submit current (within 1 year) appraiser's valuation of structure)				
Cumulative value of improvements:				
Substantial improvement:	Yes	No	(Yes, if cost of project 50% of appraised valuation)	



**Floodplain Development Permit and Application Form**

FLOODPLAIN INFORMATION					
Note to Applicants: Fill out as much information as possible. If you have questions, or need assistance filling out this form, contact the City of Kingsville Planning Department.					
FEMA Flood Zone Designation	A	AE	AO	X (shaded)	X (unshaded)
Base Flood Elevation:			NGVD (29)	NAVD (88)	
Required Flood Protection Elevation:			NGVD (29)	NAVD (88)	
Floodway:	Yes	No	(If yes, please submit No Rise Certification)		
REGULATORY REQUIREMENTS					
Structure is:	elevated	flood-proofed	vented	n/a	
Elevation Certificate:	Yes	No			
If flood-proofed, describe method:					
Lowest floor elevation:			NGVD (29)	NAVD (88)	
Elevation of garage slab:			NGVD (29)	NAVD (88)	
Lowest elevation of HVAC equipment: (and other mechanical equipment)			NGVD (29)	NAVD (88)	
Enclosed area (not flood-proofed or elevated)				square feet	
Number of vents:			Area of vents:	square inches	
<b>FOR STRUCTURES: Attach building plans showing foundation design, flood elevation, floor elevations, HVAC and other mechanical equipment elevations, size and location of vents, flood-proofing design and other relevant information that address those standards set forth in Section 15-4-5. A pre-construction elevation certificate is also required.</b>					
<b>FOR SITE WORK: Attach site and grading plans and other relevant information.</b>					
<b>Certification:</b> I certify that the above information is correct and agree to construct this building in accordance with the plat, building plans and specifications submitted, and in strict compliance with all the provisions of the Zoning Ordinance, Building Code, of the City of Kingsville.					
Signature of applicant:				Date:	
Printed name:					
Signature of Floodplain Administrator:				Date:	
Comments:					



**CITY OF KINGSVILLE  
LICENSE APPLICATION FOR CONTRACTORS**

**LICENSES ARE VALID FROM DATE OF ISSUANCE TO DECEMBER 31**

**BUSINESS NAME:** \_\_\_\_\_

**BUSINESS ADDRESS:** \_\_\_\_\_  
\_\_\_\_\_

**BUSINESS TELEPHONE:** \_\_\_\_\_

**LICENSEE MAILING ADDRESS:** \_\_\_\_\_  
\_\_\_\_\_

**EMAIL:** \_\_\_\_\_

**CELL PHONE:** \_\_\_\_\_

**LICENSE TYPE:** \_\_\_\_\_

**METHOD OF PAYMENT: WE ONLY ACCEPT CHECKS / MONEY ORDERS / DEBIT, MASTERCARD OR VISA**

<b>LICENSE FEES</b>	
<b>GENERAL CONTRACTOR</b>	<b>\$125 .00</b>
<b>(SIGN, DEMOLITION, SWIMMING POOL, FOUNDATION AND HOUSE MOVING)</b>	
<b>IRRIGATION CONTRACTOR</b>	<b>\$95.00</b>

- 1. MECHANICAL, ELECTRICAL AND PLUMBING CONTRACTORS MUST SHOW THEIR DRIVER'S LICENSE, LIABILITY INSURANCE AND TRADE LICENSE.**
- 2. NO LICENSE WILL BE ISSUED UNTIL PAYMENTS ARE RECEIVED.**
- 3. APPLICATION MUST BE FILLED IN COMPLETELY BEFORE RECEIVING A LICENSE.**
- 4. RATES CAN NOT BE PRO-RATED.**

Phone: (361) 595-8019 / email: [tcavazos@cityofkingsville.com](mailto:tcavazos@cityofkingsville.com)

This form available on our website: <https://www.cityofkingsville.com/departments/planning-and-development-services/>

## Application Check List for Special Use Permits

The following must be submitted prior to the application deadline. Otherwise, the application will be deemed incomplete and may result in unnecessary delays: (Please ✓ when complete)

Site and landscape plans: Applicant must provide 15 - 11"x17" or 8 ½"x11" copies of the plans, plus the following:

- \_\_\_ 1. Written description of the use i.e. hours of operation, scope of work, number of employees, etc...
- \_\_\_ 2. The location, dimension, material and configuration of all buildings, structures and other improvements.
- \_\_\_ 3. The location and extent of usable open space.
- \_\_\_ 4. The location, access and other dimensions of proposed off-street parking and loading facilities and the number and configuration of spaces to be provided.
- \_\_\_ 5. The location, dimensions and materials of sidewalks, driveways and other impervious surfaces.
- \_\_\_ 6. The location and intensity of illumination of any illuminated areas.
- \_\_\_ 7. The proposed use of open space.
- \_\_\_ 8. A landscaping plan, which shall include existing and proposed landscaping on both the subject property and adjacent public areas and including an installation schedule.
- \_\_\_ 9. The location of all utilities, including electric lines, storm drainage, sanitary sewers and water service.
- \_\_\_ 10. The location and extent of required setbacks and yards.
- \_\_\_ 11. The elevation of all buildings and structures to depict height.
- \_\_\_ 12. The lot size in square feet and the dimensions thereof.
- \_\_\_ 13. Any areas proposed for outdoor storage, refuse collection, exterior mechanical equipment, exterior communication devices and utility apparatus.
- \_\_\_ 14. The dimensions, location and landscaping of required landscape/buffer setbacks and screening.
- \_\_\_ 15. The land uses surrounding the lot(s) for which site plan approval is being sought.
- \_\_\_ 16. The zoning on the lots and parcels surrounding the lot(s) for which site plan approval is being sought.
- \_\_\_ 18. Such additional information as the Director of Development Services may deem pertinent and essential to the application.

**Please note that this process can take up to 100 days.**

**Also, make sure you contact 595-8020 for information on City-required inspections and certificate of occupancy.**



## **Minimum Requirements for Food Establishments**

The following information provides basic information for the operation of a licensed food establishment. The food establishment operators are encouraged to contact their local regulatory agency for specific changes or additions to these guidelines.

### **Contact City Departments**

- Planning & Permit Department (Inspectors electrical, plumbing & building) 361-595-8019
- Fire Department (Fire Marshall) 361-592-6445
- City of Kingsville-Health Department (Health Inspector) 361-592-3324

### **Inspection of Establishment by the City-County Health Department**

- Inspection and approval is required before opening for business.
- Contact the City of Kingsville-Health Department to schedule a final inspection **BEFORE** opening for business.
- A Certified Food Manager is required to be on staff.
- All employees must have a food handler card.

### **Water Supply**

- Water shall be from a public water system or an approved individual source that meets State water drinking requirements.

### **Sewage**

- All sewage shall be disposed into a public sewage or an individual sewage disposal system that meets State and Local requirements.

### **Grease Trap**

- Refer to Planning and Permit Department (Plumbing Inspector) for Specifications.

### **Grease Tank**

- A grease holding tank and certified grease hauler is required for establishments generating grease.

### **Walls and Ceilings**

- Ceilings and Wall surfaces in food preparation, food serving, warewashing, storage areas and toilet rooms must be smooth, non-absorbent, easily cleanable and in good condition.
- Studs, joist and rafters may not be exposed in areas subject to moisture.
- Utility lines and pipes must not be unnecessarily exposed and must be installed so they do not obstruct or prevent cleaning of the floors, walls or ceilings.

**Floors**

- \_\_\_ Floor surface in food preparation, food serving, warewashing, storage areas and toilet rooms must be smooth, non-absorbent, easily cleanable and in good condition.
- \_\_\_ Floor-wall junctures must be covered and sealed.
- \_\_\_ No carpeting allowed in food preparation, food serving, warewashing, storage areas and toilet rooms.
- \_\_\_ Exposed horizontal utility service lines and pipes may not be installed on the floor.

**Shelving and Cabinets**

- \_\_\_ Unfinished construction is not allowed.
- \_\_\_ Wooden shelves or racks are not permitted in refrigerated storage areas.
- \_\_\_ Shelving and racks shall hold food and food-contact items a minimum of 6 inches off the floor.

**Handwashing Lavatories**

- \_\_\_ Designed only for handwashing.
- \_\_\_ Shall be accessible and conveniently located in food prep, food serving and warewashing areas, and in, or immediately adjacent to toilet rooms.
- \_\_\_ Shall be equipped with cold and hot water (minimum 100 °F) and shall meet the hot water demands throughout the establishment.
- \_\_\_ Soap and paper towels shall be conveniently provided at all times.
- \_\_\_ A sign, icon, or poster that notifies food employees to wash their hands shall be provided at all handwashing lavatories used by food employees and shall be clearly visible to food employees.

**Warewashing Facilities**

- \_\_\_ A minimum three-compartment sink is required for manual washing, rinsing and sanitizing of equipment and utensils.
- \_\_\_ Proper sanitizers and test strips are required to check parts per millions.
- \_\_\_ All warewashing sinks shall be large enough to permit the complete immersion of the largest piece of portable equipment.
- \_\_\_ Mechanical dishwashing machines may supplement but not replace the manual three-compartment sink requirements. Mechanical machines shall be of commercial grade using hot water (171 °F) or an approved chemical sanitizer.

**Food Prep Sink**

- \_\_\_ A separate sink can be used for food preparation, or food preparation can be conducted in the three-compartment sink after it has been cleaned and sanitized.

**Service Sink**

- \_\_\_ At least one service sink or cubed cleaning area shall be provided for the cleaning of mops and similar wet floor cleaning tools and for the disposal of mop water and similar liquid waste.
- \_\_\_ Mop water cannot be disposed in the food preparation sinks, warewashing sinks, handwashing sinks or toilets.
- \_\_\_ A vacuum breaker or approved backflow prevention device shall be installed if a hose is connected.

**Plumbing**

- \_\_\_ Water heater shall provide a constant and ready source of hot water to all supplied fixtures.
- \_\_\_ There shall be no direct connection between the sewage system and any drains originating from

equipment in which food or utensils are placed, such as ice machines, food preparation sinks, warewashing sinks, floor drains in walk in refrigeration units, steam tables and salad bars. These fixtures shall be drained into the sewage system through a minimum 1-inch vertical air gap.

- \_\_\_ Air gaps between the water inlet and flood level rim of the plumbing fixture, equipment, or non food equipment shall be twice the diameter of water supply inlet and may not be less than 1 inch.

### Equipment

- \_\_\_ Equipment designed and constructed for commercial use shall be used in food establishment. Residential home refrigerators, freezers, ranges and ovens **MAY NOT WITHSTAND HEAVY USE.**
- \_\_\_ Sufficient refrigeration equipment to maintain potentially hazardous foods (PFH's) at 41°F or below during all hours of operation. Potentially hazardous foods are foods that are capable of supporting the rapid growth of pathogens or toxigenic microorganisms (example; raw meats, poultry, pork, fish, cut melons and dairy products).
- \_\_\_ Freezers shall maintain a temperature of 0°F or below. Items shall be frozen (solid feel) during all hours of operation.
- \_\_\_ Sufficient equipment for hot holding (buffet tables, ect.) PHF's at 135°F during all hours of **operation.**
- \_\_\_ Sufficient equipment to reheat to 165°F within 2 hours.
- \_\_\_ Accurate thermometers shall be provided in all refrigeration units. Built in thermometers are suitable provided that they work and are accurate.
- \_\_\_ Stem type cooking thermometers shall be provided to monitor food temperatures. They must be sanitized between each use.

### Toilet Rooms

- \_\_\_ Toilet rooms shall conform to all Health Codes, Building and Plumbing requirements.
- \_\_\_ Toilet facilities shall be conveniently located and shall be accessible to employees at all times.
- \_\_\_ Toilet rooms shall be completely enclosed and have tight fitting, self-closing doors.
- \_\_\_ Toilet rooms used by females shall be provided with a covered receptacle for sanitary napkins.
- \_\_\_ Toilet tissue shall be available at all times.
- \_\_\_ Toilet rooms shall display an **Employee must hand-washing sign** at all times.

### Lighting

- \_\_\_ Light bulbs shall be shielded, coated or otherwise shatter resistance in areas where there is exposed food; clean equipment, utensils and linens; or unwrapped single service and single use articles.

### Garbage and Reuse Disposal

- \_\_\_ Garbage and reuse containers, dumpsters and compactor system shall be stored on or above a smooth surface of non-absorbent material, such as concrete or asphalt and sloped to drain.
- \_\_\_ Lids to refuse containers, dumpsters, and compactor system shall be kept closed at all times.

### Laundry Facilities

- \_\_\_ Laundering shall be restricted to washing and drying of items used in the operations of the establishments.

### Insect and Rodents Control

- \_\_\_ Outside openings shall be effectively protected by tight fitting doors, closed windows, screening or other means to prevent entry of rodents and insect.
- \_\_\_ A tracking powder pesticide may not be used in a food establishment.

- \_\_\_ Pesticide must have manufacturers label instructions that state that use is allowed in a food establishment.
- \_\_\_ A restricted use pesticide shall be applied only by an applicator certified as defined in 7 USC 136, certified Applicator for the Federal Insecticide, Fungicide, and Rodenticide Act, of a person under the direct supervision of a certified applicator.

### **Toxic Material Storage**

- \_\_\_ All poisonous or toxic materials shall be stored so they cannot contaminate food, equipment, utensils, linens and single service and single use articles by: separating by spacing or partitioning and by not placing above food, equipment, utensils, linens and single service and use articles.
- \_\_\_ A container previously used to store poisonous or toxic materials may not be used to store transport or dispense food.
- \_\_\_ All toxic items need to be properly labeled, including spray bottles and buckets of sanitizer.

### **Dry Storage Area**

- \_\_\_ Food and paper products are to stored 6" off the ground.
- \_\_\_ All foods must be from an approved source.

### **Self-Service Area**

- \_\_\_ Self-service displays shall be protected from contamination by the use of sneeze guards.
- \_\_\_ Buffet plate sign shall be posted directing customers to use clean plates for return helpings.
- \_\_\_ Ice bins shall be covered to prevent contamination.

### **Consumer Advisories**

- \_\_\_ Appropriate consumer advisories shall be posted.
- \_\_\_ Raw Shellfish warning
- \_\_\_ Buffet Plate signs
- \_\_\_ If required a HCCAP plan must be submitted.

### **Application, Fee and Permit**

- \_\_\_ Permit requirement, a person may **NOT** operate a food establishment without a valid permit or license to operate issued by the Regulatory Health Authority.
- \_\_\_ Once the approval to operate has been granted by the Health Department, the Planning Department at City Hall will issue the permit.
- \_\_\_ Permit fee shall be \$150.00 annually
- \_\_\_ Permit shall be placed in a location conspicuous to consumers.
- \_\_\_ Permits are Not Transferrable.
- \_\_\_ If an establishment will be bagging ice or manufacturing food for retail a manufacturing food license issued by the Texas Department of State Health Services is required. **DSHS (956) 423-0130**

**❖ LATEST FOOD ESTABLISHMENT INSPECTION REPORT MUST BE POSTED IN A CONSPICUOUS PLACE FOR ALL CUSTOMERS TO SEE!**

**❖ Notice: CUSTOMER'S CAN REQUEST TO SEE THE LATEST FOOD ESTABLISHMENT REPORT.**

**City of Kingsville Health Department-Food Service Division**

3421 North Farm Market 1355 \* P.O. Box 1458 \* Kingsville, Texas 78364 \*361-592-3324



**Retail Food Establishments Inspection of Occupancy**

Establishment: \_\_\_\_\_ Owner: \_\_\_\_\_

Physical Address: \_\_\_\_\_ Zip: \_\_\_\_\_ Phone: \_\_\_\_\_

**ITEMS MARKED X MUST BE CORRECTED**

❖ **Equipment**

- Refrigeration 41°F or below
- Freezers 0° or below
- Heating/Hot-holding 135°F or above
- Accurate thermometer provide in units
- Stem type thermometers provided with alcohol swabs
- Equipment designed and constructed for commercial use

❖ **Ware-washing**

- Three-compartment sink
- Sanitizers and Test Strips
- Compartment large enough for immersion of largest piece of portable equipment
- Mechanical dish washer 180°F/or chemical sanitizer

❖ **Hand-washing Lavatories**

- Designated only for hand-washing
- Accessible/Conveniently located in required areas
- Soap and towels provided
- Employee hand-washing sign

❖ **Floors, Walls & Ceilings**

- Smooth, Non-absorbent & Easily Cleanable
- Utilities lines, stud joints, rafters not exposed
- Floor/Wall junctures covered and sealed
- No unfinished construction

❖ **Plumbing**

- Water: Hot/Cold throughout the facility
- No direct connection from food contact equipment to sewer line
- Air-gap twice the diameter of inlet/no less than 1 inch

❖ **Service Sink**

- Service sink/Curbed cleaning area
- Backflow prevention device (if hose is attached)

❖ **Toxic Material Storage**

- Stored as to not contaminate food
- Properly labeled

**Toilet Rooms**

- Conveniently located and accessible
- Tight fitting, self-closing doors
- Trash can provided (females covered)
- Toilet tissue

**Garbage and Refuse Disposal**

- Container stored on smooth surface sloped to drain
- Property covered
- Grease Tank

**Lighting**

- Light fixtures shielded

**Insect and Rodent Control**

- Outer openings protected

**Dry Storage**

- All food/paper products 6" of ground
- Approved Source (ONLY)

**Self Service Area**

- Sneeze guards
- Ice bin covered

**Consumer Advisories**

- HACCP plan
- Raw Shellfish Warning
- Buffet Plate

**Employees**

- Food Manager Certification
- Food Handler Cards

Inspected by: \_\_\_\_\_ Date: \_\_\_\_\_

Received by: \_\_\_\_\_ Title: \_\_\_\_\_

{ } APPROVED

{ } NOT APPROVED



City of Kingsville - Health Department  
Kingsville, Texas  
Things needed to pass Kitchen Inspection

---

**EQUIPMENT:**

- 1) Make sure you have thermometers inside all refrigerators / freezers / box freezers.
- 2) Make sure any unit/equipment, used for hot foods, can maintain a temperature of 135F or above and cold foods 41F or below.
- 3) You will need a food thermometer with alcohol swabs (used to sanitize stem of thermometer)
- 4) Equipment designed and constructed for commercial use
- 5) Commercial water heaters & water tanks designed for water storage/retention

**WAREWASHING:**

- 1) Need a 3-compartment sink & make sure you have a dry board (shelves, etc...place to dry your dishes
- 2) Need sanitizers (commercial sanitizer or plain Clorox) and chlorine test strips (can only be purchased in CC at a restaurant supply store) Make sure you buy the sanitizing strips according to the solution you will be using. (purple – Clorox & green – commercial)
- 3) Your 3-compartment sink should be large enough to wash your largest pot/pan

**HANDWASHING LAVATORIES:**

- 1) Need another sink, apart from 3-compartment sink designated only for washing hands
- 2) Sink needs to have soap/towels
- 3) Need to post a sign that designates this sink for hand washing only (copy attached)

**FLOORS, WALLS, CEILINGS:**

- 1) Smooth, Non-absorbent, Easily Cleanable
  - 2) Utility lines, stud joints, rafters not exposed
  - 3) Floor/Wall junctures covered and sealed
  - 4) No unfinished construction
- Any gaps, holes, etc – seal off with foam insulation or caulking, etc. Make it look nice!!

**PLUMBING:**

- 1) Must have hot & cold water
- 2) NO direct connection from food contact equipment to sewer line
- 3) Air-gap twice the diameter of inlet/no less than 1 inch

**SERVICE SINK:**

- 1) Must have a utility sink – this is where the mop water will be thrown, since it can't just be thrown outside. Needs to be plumbed into the plumbing.  
\*\* Not needed in mobile units; however, must have a plan where to throw out the dirty water after mopping.

**TOXIC MATERIAL STORAGE:**

- 1) Make sure any bottles/containers with chemicals are labelled with marker or sticker, etc.
- 2) Store all chemicals separate from any food shelves or any food items, etc.

**TOILET ROOMS:**

- 1) Need to be clean & stocked with toilet paper, soap/paper towels
- 2) Doors need to be tight fitting, self-closing door (hydraulic or spring)
- 3) Women's bathroom needs a covered trashcan (for sanitary napkins, etc)
- 4) Need a sign in bathrooms that tells employees they need to wash their hands before returning to work (copy attached)

Note: Mobile unit usually don't have bathrooms, so disregard this section

**GARBAGE & REFUSE DISPOSAL:**

- 1) Need covered trash can in kitchen
- 2) Need to properly dispose of oils
- 3) If grease tank required, need to lease one or have a written plan in place for inspector on how you will dispose of grease.

**LIGHTING:**

- 1) Light fixtures shielded (if no cover on light, then clear tubing case is acceptable)

**INSECT & RODENT CONTROL:**

- 1) Outer openings protected
  - a. Make sure all doors are sealed properly, if not – put weather stripping
  - b. Make sure no gaps or holes in walls & ceilings throughout building/mobile

**DRY STORAGE:**

- 1) All food and paper good items must be 6 inches off the ground
  - a. Can goods, bottle drinks, can drinks can be store on floor, but must be dry
  - b. Tubs/5-gallon buckets with tight covered lids allowed on floor, but again must be dry

**SELF SERVICE AREA:**

- 1) Ice bins must be covered

**CONSUMER ADVISORIES:**

- 1) If Buffet – must have a sign that say that customers must come back with a clean plate

**EMPLOYEES:**

- 1) Anyone serving/cooking/prepping food must obtained a state approved food handler card

- 2) A certified food manager is required to be on staff, but not needed to be on duty 24/7; however, if no food manager on staff and have a major violation – you will get a 2 pt violation.

**OTHER:**

- 1) Need to post current food license/permit in public view
  - 2) Need to post a sign that notifies your customers that your most recent inspection is available upon request
  - 3) Need a 1<sup>st</sup> Aid Kit in a box
  - 4) Beard guards need to be available for men with any facial hair (mustache, beard, etc)
  - 5) Need to have disposable gloves on hand
  - 6) Need hair restraint (cap, hairnet, etc)
- Also see mobile unit checklist for other requirements for mobile unit!!

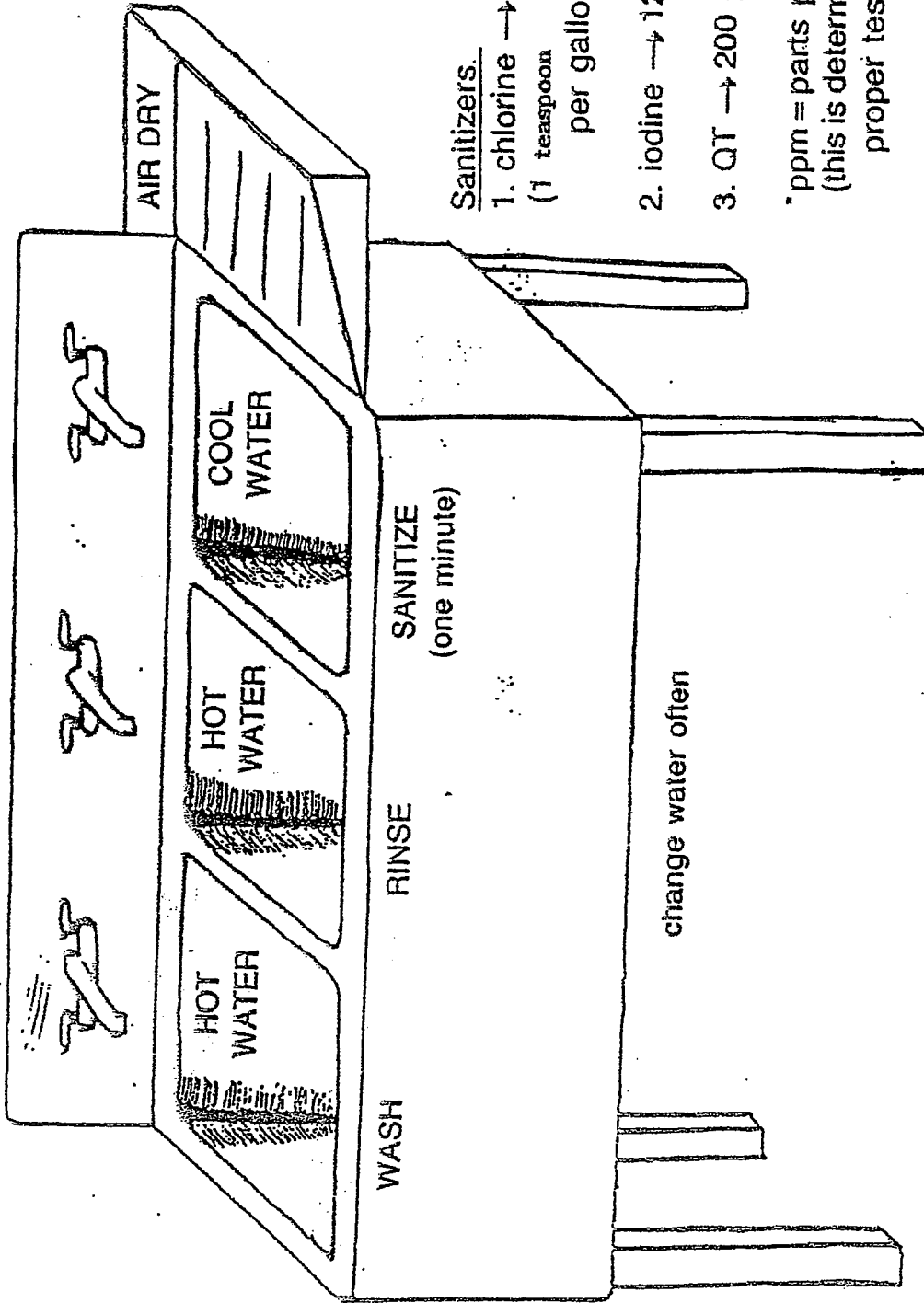

Sanitizers.

1. chlorine → 50 - 100 ppm  
(1 teaspoon bleach per gallon)
2. iodine → 12.5 - 25 ppm
3. QT → 200 ppm

\* ppm = parts per million  
(this is determined with proper test strip)

CITY-COUNTY HEALTH DEPARTMENT  
3421 NORTH F.M. 1355  
KINGSVILLE, TEXAS 78363

Example of  
Hand washing  
Sign

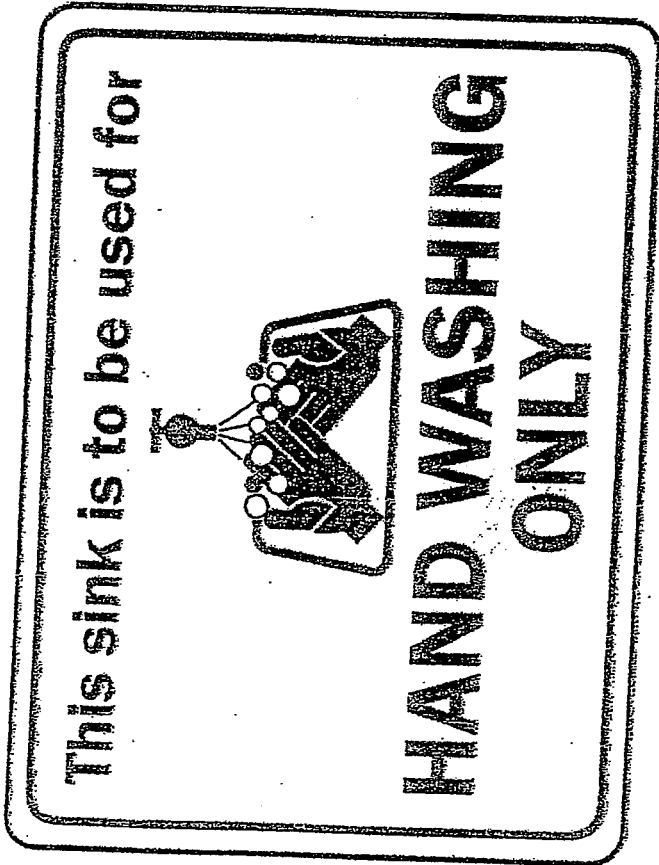

Example of  
Toilet Room  
Sign



**EMPLOYEES  
MUST WASH HANDS  
BEFORE RETURNING TO WORK!**

**CITY OF KINGSVILLE INSPECTION OF OCCUPANCY**  
*City of Kingsville-Health Department/Food Service Division*



**NAME OF BUSINESS:** \_\_\_\_\_

**TYPE OF BUSINESS:** \_\_\_\_\_

**ADDRESS:** \_\_\_\_\_

**BUSINESS TELEPHONE #** \_\_\_\_\_

**OWNER/MANAGER:** \_\_\_\_\_

**ADDRESS:** \_\_\_\_\_

**MANAGER/OWNER TELEPHONE #** \_\_\_\_\_

In applying for an inspection for a certificate of occupancy, which is necessary to operate the proposed business. I understand and agree to comply with all City Ordinances and State Laws that may govern the operation of the business. It is the responsibility of the person applying for a certificate of occupancy to contact the following individuals to conduct the appropriate inspection. When this form is complete, please return to City Hall-Permit Department, 200 E. Kleberg (1<sup>st</sup> floor).

The departments that are involved for this establishment will have an **X** in the box.

- |   |          |   |          |
|---|----------|---|----------|
| <input type="checkbox"/> Building Official    | 595-8020 | <input type="checkbox"/> Fire Marshall    | 592-6445 |
| <input type="checkbox"/> Electrical Inspector | 595-8021 | <input type="checkbox"/> City Engineer    | 595-8004 |
| <input type="checkbox"/> Plumbing Inspector   | 595-8022 | <input type="checkbox"/> Health Inspector | 592-3324 |

\_\_\_\_\_  
 1. APPROVED PLUMBING INSPECTOR SIGNATURE DATE

\_\_\_\_\_  
 2. APPROVED ELECTRICAL INSPECTOR SIGNATURE DATE

\_\_\_\_\_  
 3. APPROVED FIRE MARSHALL SIGNATURE DATE

\_\_\_\_\_  
 4. APPROVED HEALTH INSPECTOR SIGNATURE DATE

\_\_\_\_\_  
 5. CERTIFICATE OF OCCUPANCY SIGNATURE (Must be last inspection-Building Official DATE



**TEXAS**  
Health and Human  
Services

Texas Department of State  
Health Services

**Consumer Protection Division  
Policy, Standards, Quality Assurance Section  
Public Sanitation and Retail Food Safety Unit**

### **Standard Operating Procedures and Policies**

April 8, 2002 (Revised 09/05/19)

**Subject: Minimum Requirements for Outdoor Barbeque Pits**

#### **Background / Purpose:**

Commercial outdoor cooking on barbeque pits is a common practice in Texas. Although many of the establishments have been in existence for many years, our first responsibility is to protect public health. Barbeque pits are used in many types of facilities, both old and new. The following guidelines should be used during an inspection to determine the requirements for the various types of barbeque facilities.

#### **Requirements Based Upon the Type of Facility:**

##### **1.) Fixed Food Establishment**

Outdoor barbeque pits at a fixed food establishment shall have, as a minimum, an overhead cover, an enclosed screened shelter and floors that are surfaced with concrete, asphalt, gravel or similar materials. No food preparation activities, other than cooking on the pit, are allowed unless handwash facilities, with hot and cold water, are available in the shelter.

##### **2.) Temporary Food Establishments**

The barbeque pits that are operated at a temporary food establishment shall meet the requirements as outlined in TFER, section 228.222. Overhead protection is required at the preparation area and is required at the pit area, if food preparation activities occur at the pit area. Enclosure and screening of the preparation area will be required if there is any evidence of insect, rodent, or other pest contamination. Temporary handwash facilities must be available at the preparation site.

Public Sanitation and Retail Food Safety Unit • PO Box 149347, Mail Code 1987 • Austin, Texas 78714-9347  
(512) 834-6753 • Facsimile: (512) 834-6683 • <http://www.dshs.texas.gov/foodeestablishments/>

### 3.) Mobile Food Units

Barbeque pits that are on or attached to a mobile food unit do not have to be screened unless there is evidence of insect, rodent, or other pest contamination at the pit. A barbeque pit may be separate from and adjacent to the main mobile food unit, but the barbeque pit shall maintain mobility. A mobile food unit shall not operate out of a "pit room" or fixed smoker, unless it has been permitted as a retail food establishment. All preparation (cutting, slicing, seasoning, etc.) should be conducted inside of the unit, which must have all required handwashing sinks and warewashing sinks. All cooking on the barbeque pits must be done with overhead protection.

4.) Exceptions may be considered on a case-by-case basis.

Agree to form and substance:



Rod Moline, Ph.D., R.S.  
Rod Moline, Ph.D., R.S.  
PSQA Section Director

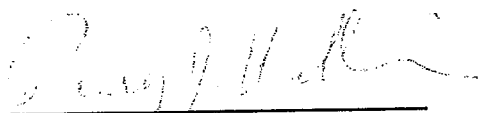

Joe Williams, R.S.  
Joe Williams, R.S.  
Manager  
Public Sanitation and Retail Food  
Safety Unit



Jaime Sepulveda, M.P.H., R.S.  
Jaime Sepulveda, M.P.H., R.S.  
Compliance Officer  
Public Sanitation and Retail Food  
Safety Unit

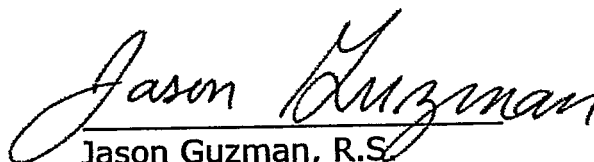

Jason Guzman, R.S.  
Jason Guzman, R.S.  
Lead Training Officer  
Public Sanitation and Retail Food  
Safety Unit

This DSHS Standard Operating Procedure and Policy preempts any previous standard operating procedure/guidance/policy letters on this subject and remains in effect until superseded in writing by the Public Sanitation and Retail Food Safety Unit. Attributed use or reproduction of this information is freely granted.





# City of Kingsville-Health Department

3421 North Farm to Market 1355/P.O. Box 1458, Kingsville, Texas 78364

Phone: (361) 592-3324

Fax: (361) 592-7621

## 2024 FOOD HANDLERS COURSE SCHEDULE

**\$15.00 per Individual**

Registration is held **15 minutes** before each class-On a First Come-First Serve Basis. Only participants are allowed in the classroom and must be a minimum of 12 years of age. Food handler certification will expire in **two years of date issued**. The classes will be held on the following **Wednesday's** at **1:30 p.m.**, **3:30 p.m.** & **5:30 p.m.** Class begin promptly and there will be **no cell phone calls or texting** allowed in the classroom.

**Doors will be locked right after the classes begin.**

<b>JANUARY</b>	<b>01/10/2024</b> <b>01/24/2024</b>
<b>FEBRUARY</b>	<b>02/07/2024</b> <b>02/21/2024</b>
<b>MARCH</b>	<b>03/06/2024</b> <b>03/20/2024</b>
<b>APRIL</b>	<b>04/03/2024</b> <b>04/17/2024</b>
<b>MAY</b>	<b>05/01/2024</b> <b>05/15/2024</b>
<b>JUNE</b>	<b>06/05/2024</b> <b>06/26/2024</b>
<b>JULY</b>	<b>07/10/2024</b> <b>07/24/2024</b>
<b>AUGUST</b>	<b>08/07/2024</b> <b>08/21/2024</b>
<b>SEPTEMBER</b>	<b>09/04/2024</b> <b>09/18/2024</b>
<b>OCTOBER</b>	<b>10/09/2024</b> <b>10/23/2024</b>
<b>NOVEMBER</b>	<b>11/06/2024</b> <b>11/20/2024</b>
<b>DECEMBER</b>	<b>12/04/2024</b> <b>12/18/2024</b>

## **COMMERCIAL PERMIT CONDITIONS**

1. **APPROVED PLANS, WITH COMMENTS, MUST BE RETAINED ON THE JOB UNTIL THE FINAL INSPECTION HAS BEEN MADE. NO BUILDING SHALL BE OCCUPIED UNTIL ALL REQUIRED FINAL AND OCCUPANCY INSPECTIONS HAVE BEEN MADE WHERE APPLICABLE. NO INSPECTION WILL BE MADE WITHOUT THE APPROVED PLANS ON THE JOB SITE.**
2. **This permit conveys no right to occupy any street, alley or sidewalk or any part thereof, either temporarily or permanently. Encroachments on public property not specifically permitted under the building code, must be approved by the City. Street or alley grades as well as depth and location of public sewers may be obtained from the Department of Public-Works-City Engineers Office. The issuance of this permit does not release the applicant from the conditions of any applicable subdivision restrictions.**
3. **The City of Kingsville reserves the rights to reject any work which has been concealed or completed without first having been inspected and approved for compliance to various codes by the Inspection Service Division.**
4. **Any deviation from the approved plans must be authorized by the approval of revised plans subject to the same procedure established for the examination of the original plans. This revision approval must be obtained prior to the proposed changes being made in the field.**
5. **A permit become invalid if construction work is not started within six months from date permit is issued. If work does not continue to progress, the permit will become invalid six months after the last inspection made.**
6. **All items noted on the job inspection record must be approved and signed by the appropriate agencies and the City. It will be the owner's and/or contractor's responsibility to see that the various inspections are called for and approved.**
7. **Approvals of these plans and/or specifications by the Inspection Services Division SHALL NOT necessarily mean that these plans or specifications are in full compliance with the City of Kingsville Building Code and other laws or Ordinances. The ARCHITECT/DESIGNER or ENGINEER certifying these plans is charged with responsibility for the compliance of the plans with the Building Code and other Law and Ordinances. Issuance of a permit does not constitute a waiver or variance from any law or ordinance governing this construction. The issuance of a permit shall not prevent the Building Inspector from thereafter requiring a correction of error or violation in plans or construction. The architect or engineer shall file a verified report at completion of construction that the structure has been erected in accordance with the approved plans and all applicable ordinances. All reports shall bear the seal signed by the Architect/Engineer. (No photo copy).**
8. **Approval of application and issuance of a building permit does not supersede any required approvals by an architectural review committee for residential properties with restrictive covenants.**
9. **The applicants, owner, and/or operator of the property address under this permit, hereby consents to all necessary inspections made by the City of Kingsville to enforce all existing codes, ordinances, and/or regulations of the City of Kingsville.**
10. **This permit does not relieve the owners, or any person in possession or control of the building, from obtaining such other permits or licenses as many be prescribed by law for the**

(as of 17 Jun 2024)

**uses or purposes for which the building is designed or intended; nor from complying with any lawful order issued the object of maintaining the building in a safe or lawful condition**

**11. Construction dumpsters must be placed on private property unless a permit is secured from Inspection Services for a dumpster in the public right-of-way.**

**Any individuals with disabilities who would like to receive the information in this publication in another form may contract the ADA Coordinator at 240-314-8100; TTY 240-314-8137.**

**Cualquier persona incapacitada que desea recibir la information de esta publication en alguna otra forma puede comunicarse con el coordinador de ADA en el telefono 240-314-8100; TTY 240-314-8137.**



**CITY OF KINGSVILLE**  
**Planning Department**  
**Building Permit Application**

Phone: (361) 595-8019 / email: [tcavazos@cityofkingsville.com](mailto:tcavazos@cityofkingsville.com)

DATE:	PERMIT#:	APPROVED BY:
JOB ADDRESS:		
OWNER'S NAME: LAST:		FIRST: M:
MAILING ADDRESS:		PHONE NO:
CITY:	STATE:	ZIP CODE:
CONTRACTOR: *		PHONE #:
SIZE/TYPE OF WORK: Square Feet: _____ <input type="checkbox"/> New <input type="checkbox"/> Remodel		
DESCRIPTION OF WORK:		
VALUATION OF WORK: \$		PERMIT FEE: \$
<p><b>* All contractors <u>must</u> be registered with the City of Kingsville</b></p> <p><b>NOTICE</b></p> <p>SEPARATE PERMITS ARE REQUIRED FOR ELECTRICAL, PLUMBING, HEATING, VENTILATING OR AIR-CONDITIONING. ALL CONTRACTORS ARE RESPONSIBLE FOR DISPOSING OF THEIR OWN DEBRIS AT THE SANITARY LANDFILL ON CR 2130. THIS PERMIT BECOMES NULL AND VOID IF WORK OR CONSTRUCTION AUTHORIZED IS NOT COMMENCED WITHIN SIX MONTHS, OR IF CONSTRUCTION OR WORK IS SUSPENDED OR ABANDONED FOR A PERIOD OF 6 MONTHS AT ANY TIME AFTER WORK HAS COMMENCED.</p>		
SIGNATURE _____		DATE _____
<p><b>"HOMEOWNER" APPLICANTS ONLY:</b> I HEREBY CERTIFY THAT I OWN AND AM NOW LIVING AT THE DWELLING FOR WHICH THIS PERMIT IS BEING ISSUED, AND THAT THE WORK IS BEING PERFORMED BY ME OR A MEMBER OF MY IMMEDIATE FAMILY. I UNDERSTAND THAT, FOR THE PURPOSES OF THIS APPLICATION, MY IMMEDIATE FAMILY IS LIMITED TO MY PARENT, CHILD OR CHILD'S SPOUSE.</p> <p align="center">INITIAL HERE _____ <b>(sign Homeowner Permit Acknowledgement Form)</b></p>		

**FOR OFFICE USE ONLY**

CURRENT ZONING FOR LOCATION:	IS ZONING APPROPRIATE FOR USE REQUIRED: <input type="checkbox"/> Yes <input type="checkbox"/> No
SETBACK REQUIREMENTS VERIFIED: <input type="checkbox"/> Yes <input type="checkbox"/> No	ARE SETBACK REQUIREMENTS MET: <input type="checkbox"/> Yes <input type="checkbox"/> No
IS THE PROPERTY IN THE AICUZ/CCLUA**: <input type="checkbox"/> Yes <input type="checkbox"/> No	DOES IT COMPLY WITH THE AICUZ/CCLUA**: <input type="checkbox"/> Yes <input type="checkbox"/> No
PROPERTY EASEMENT VERIFIED: <input type="checkbox"/> Yes <input type="checkbox"/> No	DIMENSION OF EASEMENT:
AICUZ/CCLUA** DEED NOTIFICATION: <input type="checkbox"/> Yes <input type="checkbox"/> No	** CONTROLLED COMPATIBLE LAND USE AREA (JAZB)

Show NORTH arrow on (PLOT PLAN)

LOT SIZE:

1. Width of lot \_\_\_\_\_ (in ft/in)    2. Length of lot \_\_\_\_\_ (in ft/in)

BUILDING SETBACKS (see City of Kingsville Ordinance Chap XV, Art 6, App B, Section 1 or 2):

1. Front \_\_\_\_\_    2. Right Side \_\_\_\_\_

3. Left Side \_\_\_\_\_    4. Back \_\_\_\_\_

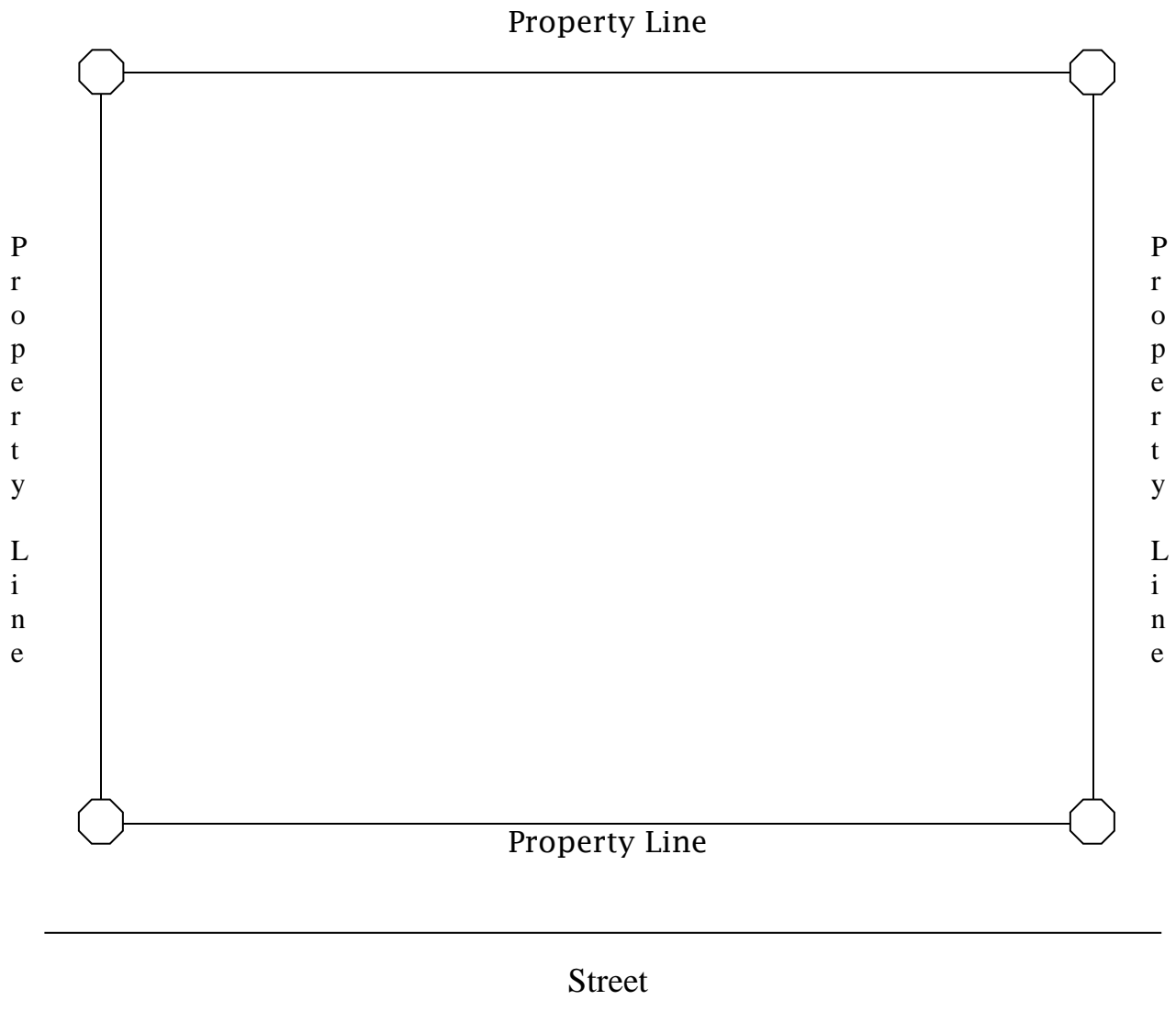

# Dumpster Enclosure Details

NO BACK ENCLOSURE

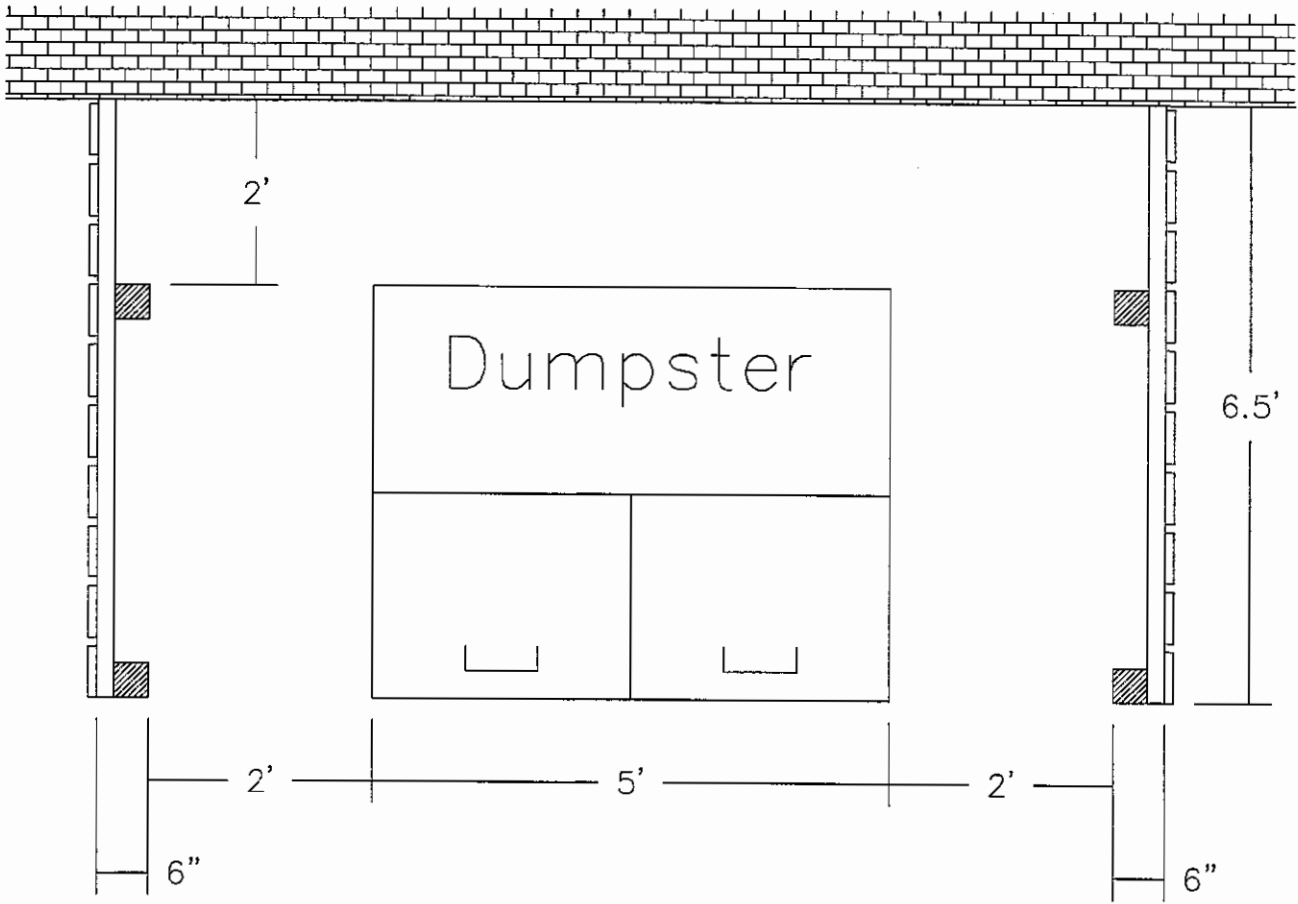

### DOUBLE ENCLOSURE

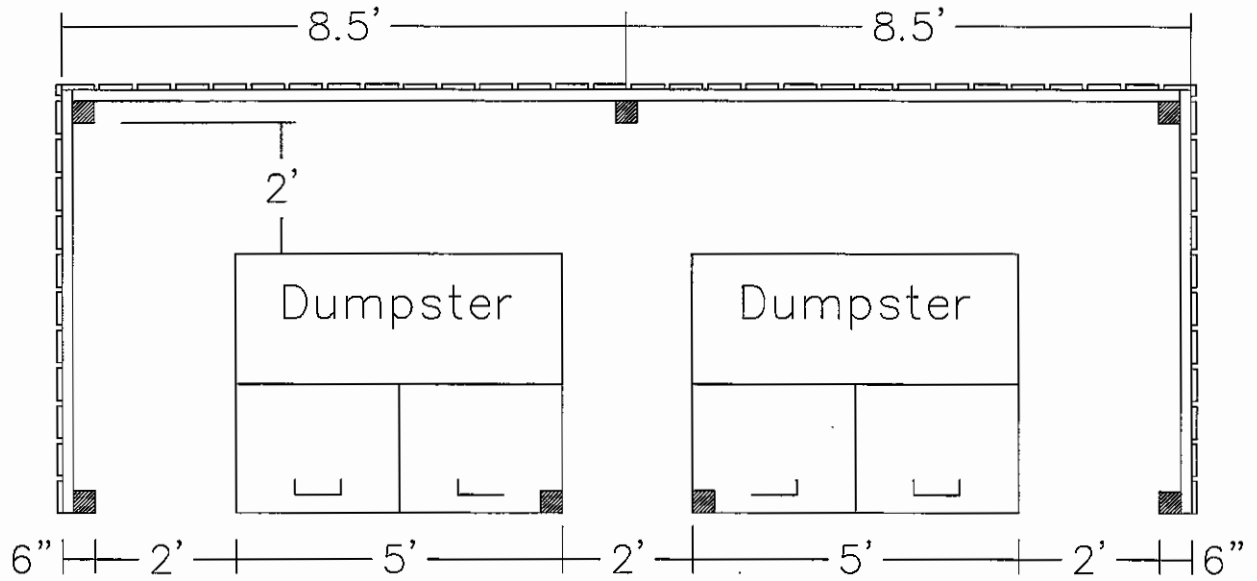



# City of Kingsville

## Permit Instructions & Application for Driveways/Sidewalks/Parking Lots

email: [tcavazos@cityofkingsville.com](mailto:tcavazos@cityofkingsville.com) / Phone (361) 595-8019

**INSTRUCTIONS: Submit one (1) application;** you may be required to submit **architectural/engineering plans** upon request and any supplemental information to ensure compliance with the City of Kingsville Code of Ordinances. **When submitting electronic plans, please place job description (“**Driveways/Sidewalks/Parking Lots**”) in the "subject" line.** Email plans to: [tcavazos@cityofkingsville.com](mailto:tcavazos@cityofkingsville.com).

Submitted drawings **must include**:

- Scaled drawing of site plan with driveway/sidewalk/parking lot location, size design and engineered standards (Architectural Plans)
- Weight limit (may require Engineering Plans)
- If installed over the public right-of-way, written permission from the City’s Public Works Director is required

**Permit applicants are required to meet conditions for all of City of Kingsville’s ordinances, some of which may not be listed below. Ordinances can be found on our city website at:**

[https://library.municode.com/tx/kingsville/codes/code\\_of\\_ordinances](https://library.municode.com/tx/kingsville/codes/code_of_ordinances)

### **Common Driveway/Sidewalk/Parking Lot Ordinances:**

Driveways, Street & Roadway Standards; Access to Businesses (Sec. 15-6-108)  
 Driveway and Permit Construction Requirements (Sec. 9-10-20 through 24)  
 Regulations for Access Driveways to State Highways Appendix, (Sec. 1-4)  
 Restricted construction; Alteration, Sidewalks, and Driveways Required (Sec. 9-10-4 and 9-10-5)  
 Alleys, Streets, & Pavement Cuts (Sec. 9-10-35, 36, 37)  
 Curb & Gutter (Sec. 15-3-50 (A&B))  
 Sidewalks (Sec. 15-3-51)  
 Landscapes in Parking Lots (Sec. 15-8-8, 9, 10)  
 Violations/penalties (Sec. 15-8-18)

**Caution: Lot lines do not normally coincide with curbs, grader ditches, or sidewalks, and many fences are not located on lot lines. If you are unsure of the exact location of the lot lines, please have a land surveyor locate them.**

The City of Kingsville **is not** responsible for locating pins or surveying your property.

Fees for Driveways/Sidewalks/Parking Lots: See City of Kingsville Permit Fee Schedule.

Inspections: Inspections can be scheduled by calling the Building Services at (361) 595-8019 within 24 hours. Please provide permit number and address of the property.

**This form available on our website: <https://www.cityofkingsville.com/departments/planning-and-development-services/>**





# City of Kingsville

## Application for Driveways/Sidewalks/Parking Lots

email: [tcavazos@cityofkingsville.com](mailto:tcavazos@cityofkingsville.com) / Phone 361-595-8019

### Project Information (Please Print)

Project Address: \_\_\_\_\_

Legal Description: \_\_\_\_\_

**Check work use and type:** \_\_\_ Residential \_\_\_ Commercial \_\_\_ Driveway \_\_\_ Sidewalk \_\_\_ Parking Lot

**Check work detail:** \_\_\_ New Driveway \_\_\_ Addition to existing driveway \_\_\_ Remove & replace driveway

\_\_\_ New Approach      **Material:** \_\_\_ Concrete \_\_\_ Asphalt \_\_\_ Pavers \_\_\_ Stone Base

**Paving Thickness:** \_\_\_ Driveway \_\_\_ Approach      **Stone Base Thickness:** \_\_\_ Driveway \_\_\_ Approach

### Name and Address of Property Owner (Please Print)

Property Owner Name: \_\_\_\_\_ Phone Number: \_\_\_\_\_

Street Address: \_\_\_\_\_

City: \_\_\_\_\_ State: \_\_\_\_\_ Zip Code: \_\_\_\_\_

Email Address: \_\_\_\_\_

### Name and Address of Applicant or Contractor (If different from Owner; Please Print)

Company Name: \_\_\_\_\_

Contact Person: \_\_\_\_\_ Phone Number: \_\_\_\_\_

Street Address: \_\_\_\_\_

City: \_\_\_\_\_ State: \_\_\_\_\_ Zip Code: \_\_\_\_\_

Email Address: \_\_\_\_\_

The undersigned hereby makes an application to construct a driveway/sidewalk/parking lot as specified herein and as shown on the drawings, and agrees to comply with the provisions of the Building and Zoning Codes, Engineering, Design Standards of the City of Kingsville, and previous info provided under permit instructions attached whether the same is specified herein or not.

Applicant Signature: \_\_\_\_\_ Date: \_\_\_\_\_

Property Owner's Signature: \_\_\_\_\_ Date: \_\_\_\_\_

Engineering Dept Approval: \_\_\_\_\_ Date: \_\_\_\_\_

Building Official Approval: \_\_\_\_\_ Date: \_\_\_\_\_

**I. Parking Area Dimensions:**

a. All parking areas shall comply with the minimum standards set forth in this section.

1. Motor vehicle parking spaces shall, at a minimum, measure eight (8) feet six (6) inches in width by eighteen (18) feet in length or by sixteen (16) feet six (6) inches in length with a one (1) foot six (6) inch overhang of the curb. If the overhang covers a portion of the adjacent sidewalk, the sidewalk shall be a minimum of six (6) feet in width.

2. All parallel parking spaces shall measure eight (8) feet six (6) inches in width by twenty-two (22) feet in length.

3. Recreational vehicle spaces shall measure ten (10) feet in width by twenty-four (24) feet in length.

4. Bicycle spaces shall measure two (2) feet in width by six (6) feet in length.

b. Minimum dimensions for parking lot design (spaces and aisles):

1. The chart on the following page depicts minimum dimensions for parking area layout.

**MINIMUM DIMENSIONS FOR A PARKING LOT LAYOUT**

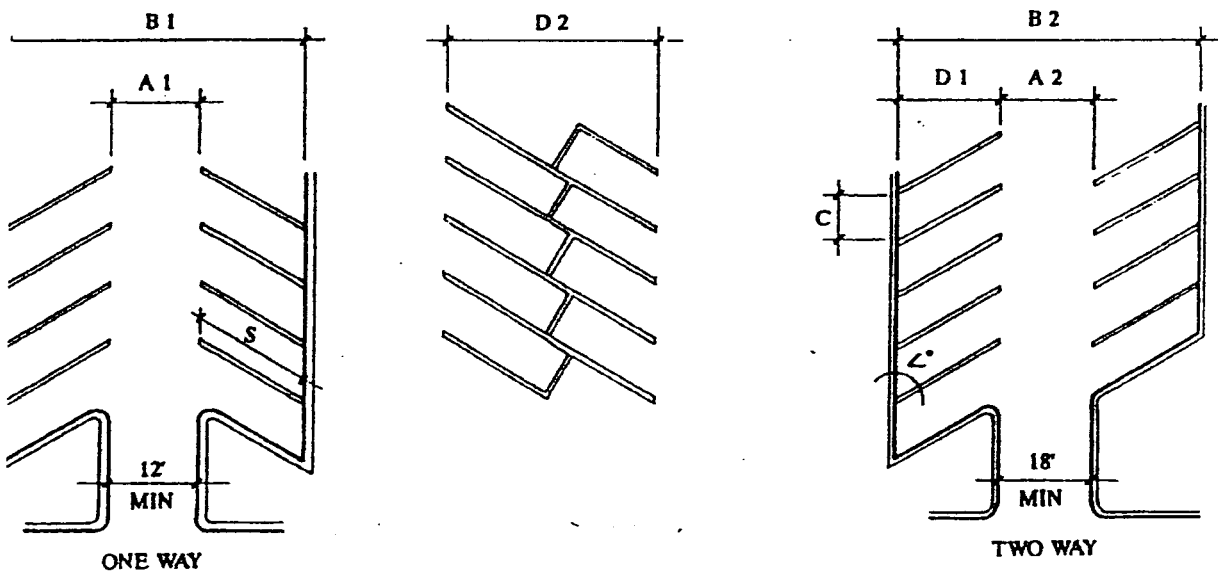

**Table 14: Minimum Dimensions for a Parking Lot Layout**

	PARKING ANGLE < °	CURB LENGTH C	STALL DEPTH		AISLE WIDTH		BAY WIDTH		STRIPE LENGTHS
			SINGLE D1	DOUBLE D2	ONE WAY A1	TWO WAY A2	ONE WAY B1	TWO WAY B2	
STANDARD SPACES	90°	8' 6"	18'	36'	23'	24'	59'	59'	18'
	60°	10'	20'	40'	17'	24'	57'	58'	23'
	45°	12'	18' 6"	37'	13'	24'	50'	55'	26' 6"
	30°	17'	16' 6"	33'	12'	24'	45'	51'	32' 8"
	0°	22'	8' 6"	17'	12'	24'	29'	35'	8' 6"
RECREATIONAL VEHICLES	90°	10'	24'	48'	24'	24'	72'	72'	24'
	60°	11' 6"	26'	46'	22'	24'	74'	74'	30'
	45°	14'	24'	41'	20'	24'	68'	68'	35'
	30°	*	*	*	*	*	*	*	*
	0°	*	*	*	*	*	*	*	*

2. The dead end of a ninety (90) degree parking aisle shall provide a five (5) foot maneuvering area the width of the aisle to assist in turning movements.

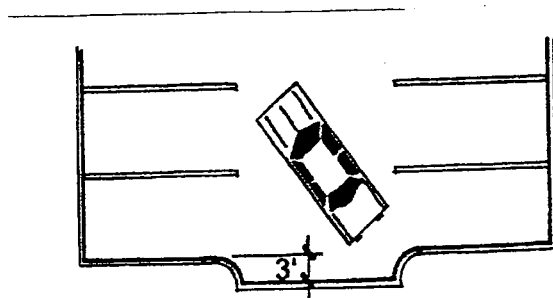

*three foot maneuvering area*

**J. Loading and Unloading Areas:**

a. Whenever the operation of any development requires that goods, merchandise, or equipment be delivered to or shipped from that development by trucks

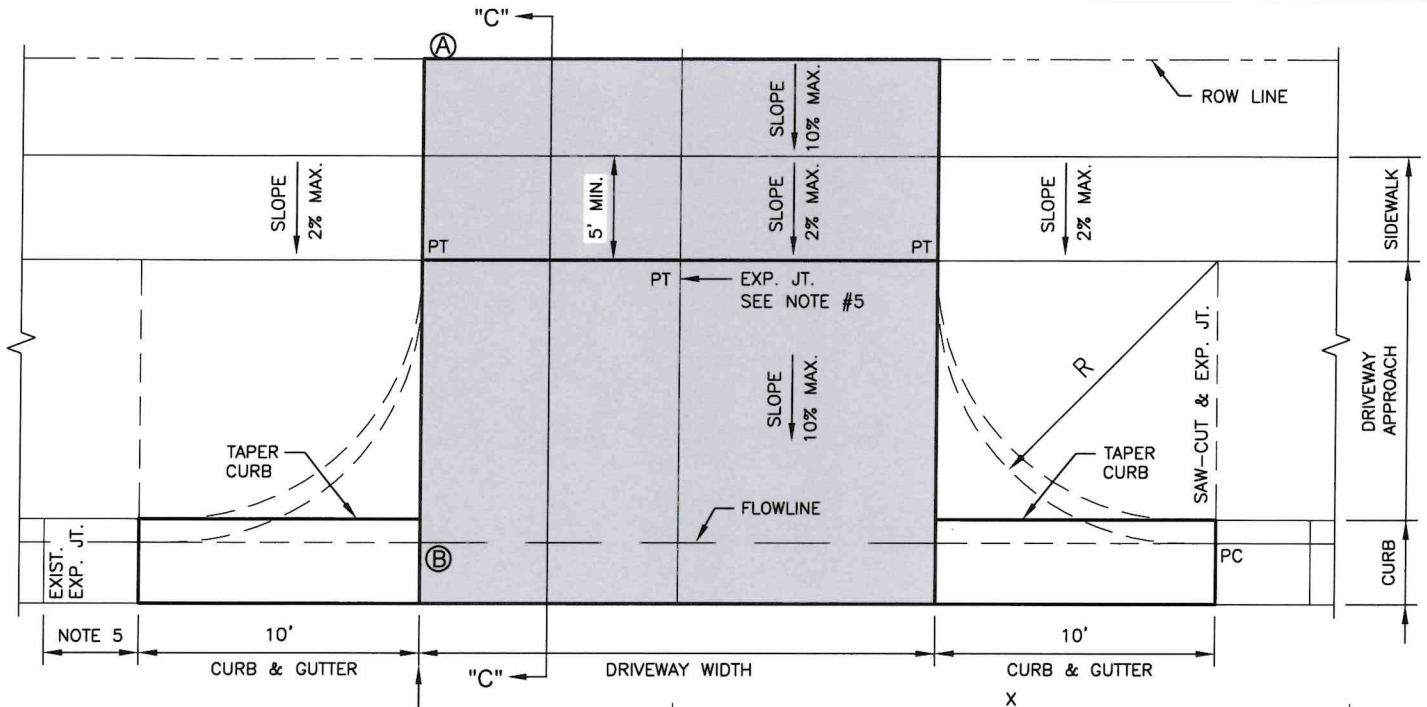

MATCH CATCH/SPILL GUTTER SECTION OF EXISTING CURB & GUTTER

NOTE: ALL DRIVEWAYS SHALL BE SLOPED TOWARDS THE STREET FROM THE ROW LINE. ELEVATION OF POINT (A) ABOVE POINT (B) IS A MIN. OF 6" PLUS 1/4" RISE/FT OVER A DISTANCE OF X.

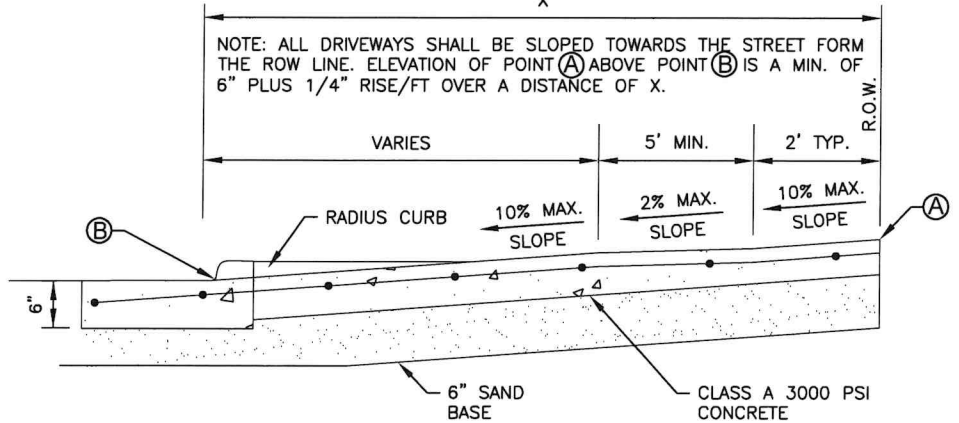

CROSS SECTION "C" - "C"

USER	THICKNESS	REINFORCEMENT	DRIVEWAY WIDTH
RESIDENTIAL DRIVEWAYS; DRIVEWAYS FOR PASSENGER VEHICLE PARKING LOTS	6" MIN.	#4 BARS @ 18" O.C.E.W.	9' MIN. - 24' MAX.
NON-RESIDENTIAL	7" MIN.	#4 BARS @ 12" O.C.E.W.	24' MIN. - 35' MAX.

- DRIVEWAY RADIUS ENDS ARE OPTIONAL.
- DRIVEWAY WIDTHS AND RADII DIMENSIONS, ONE/TWO WAY TRAVEL REQUIREMENTS, AND GEOMETRIC LAY-OUT ARE HIGHLY VARIABLE SUBJECT TO SITE SPECIFIC CONDITIONS AND REQUIREMENTS.
- "ZERO" CURB AT PT. TRANSITIONS SIDEWALK TO MATCH DRIVEWAY.
- PLACE AN EXPANSION JOINT DOWN THE CENTER OF DRIVEWAYS WIDER THAN 30 FEET.
- IF DIMENSION IS LESS THAN FIVE FEET, REMOVE CURB AND GUTTER TO EXISTING EXPANSION JOINT AND POUR MONOLITHICALLY WITH DRIVEWAY.
- IF THE BASE IS OVER-EXCAVATED WHERE THE CURB AND GUTTER WAS REMOVED, BACKFILL WITH CONCRETE MONOLITHICALLY WITH DRIVEWAY.
- DRIVEWAYS ARE TO BE LOCATED NO CLOSER TO THE CORNER OF INTERSECTING RIGHTS OF WAY THAN 60 PERCENT OF PARCEL FRONTAGE OR 100 FEET; WHICHEVER IS LESS.
- DRIVEWAYS SHALL NOT BE CONSTRUCTED WITHIN THE CURB RETURN OF A STREET INTERSECTION.
- WHILE THE PROPERTY OWNER REMAINS RESPONSIBLE FOR GRADE BREAKS WITHIN PRIVATE PROPERTY, THE FIRE DEPARTMENT SHOULD BE CONSULTED WHERE THE DRIVEWAY IS ESSENTIAL TO EMERGENCY VEHICLE ACCESS AND "C2" IS GREATER THAN 15%.
- USE 1/2" ASPHALT BOARD OR OTHER APPROVAL MATERIAL FOR CURB AND GUTTER EXPANSION JOINTS, SIDEWALKS, AT THE ROW LINE, AND AT MIDWIDTH (NOTE 4).

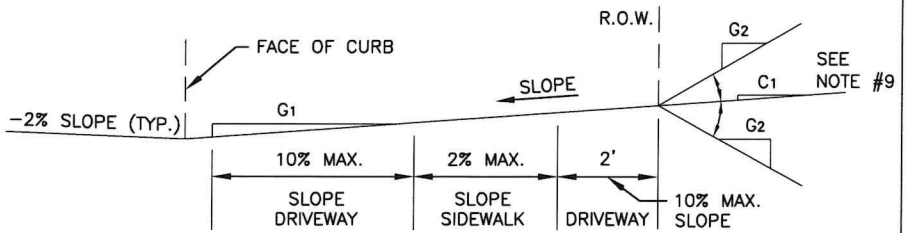

DRIVEWAY VOLUME (ADT)	D= GRADE CHANGE	
	STD.	MAX.
> 1,500	0%	3%
500 - 1,500	3%	6%
< 500	6%	15%

REVISED  
05-31-2023

SHEET 1	<b>CITY OF KINGSVILLE</b>	Drawn by: J. RAMIREZ		CITY OF KINGSVILLE ENGINEERING DEPARTMENT 400 West King Kingsville, Texas 78363 Office 361.595.8007 Fax 361.595.8035
	<b>CONCRETE DRIVEWAY DETAILS</b>	Date: 04-12-2023		
		Checked by: R. MORA		
		Job:		
		Scale: AS NOTED		

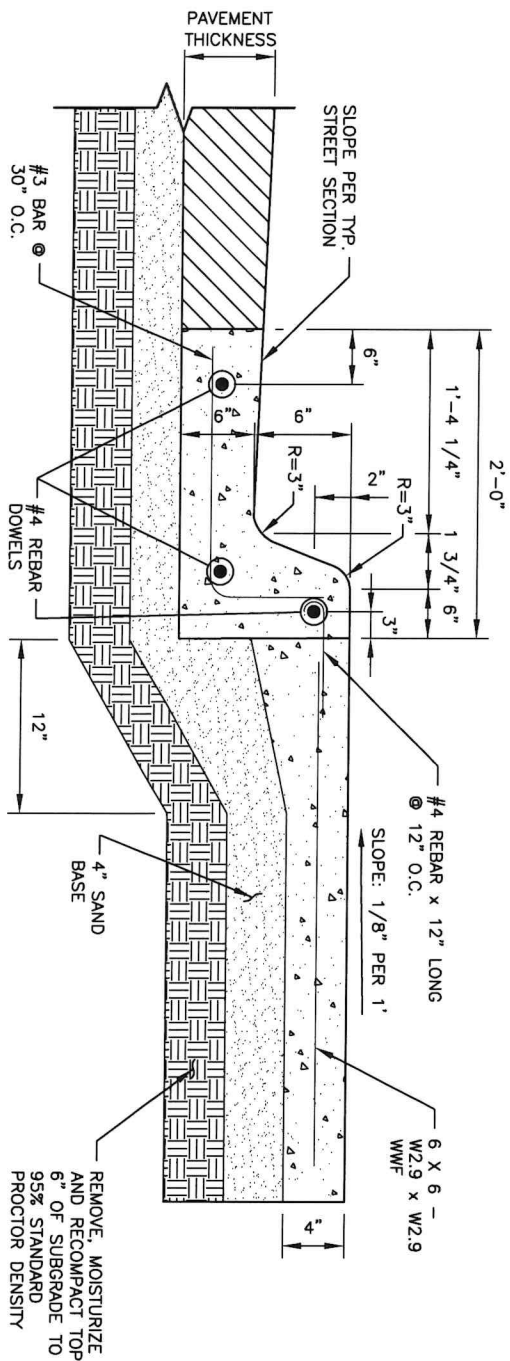

**A**  
SECTION  
1  
N.T.S.

REVISED  
05-31-2023

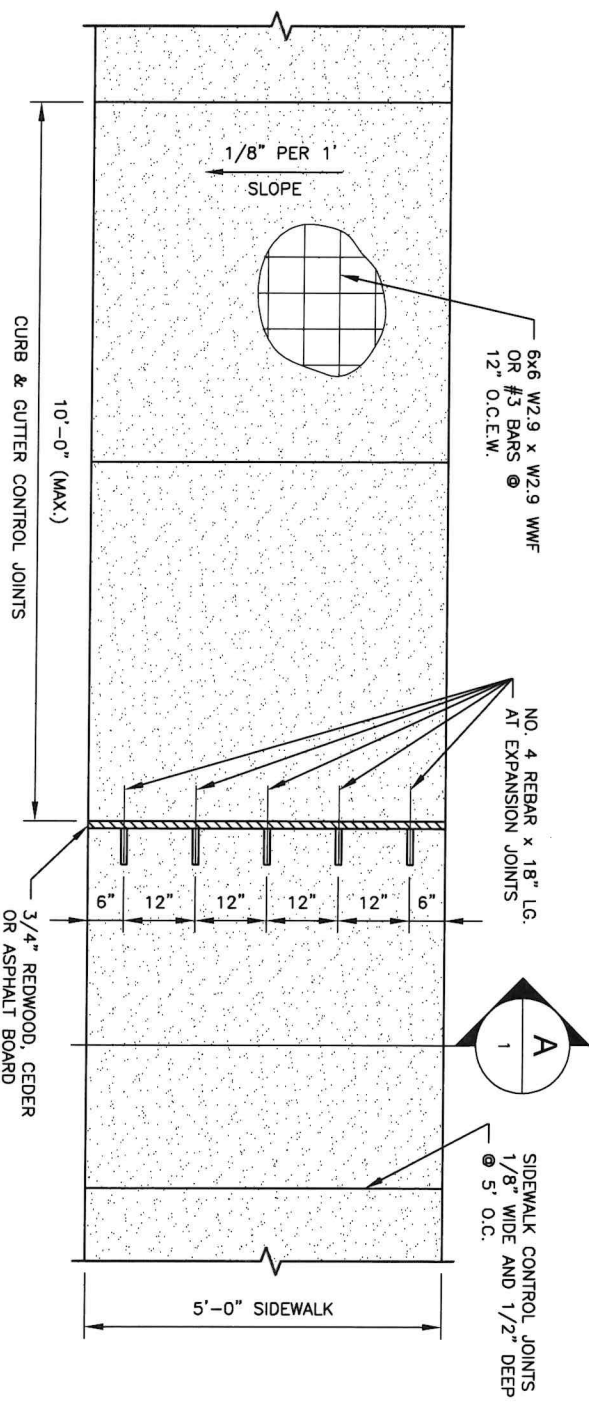

**1**  
CONCRETE SIDEWALK DETAIL  
1  
N.T.S.

**CITY OF KINGSVILLE**  
**SIDEWALK DETAILS**

Drawn by: J. RAMIREZ  
Date: 04-12-2023  
Checked by: R. MORA  
Job:  
Scale: AS NOTED



CITY OF KINGSVILLE  
ENGINEERING DEPARTMENT  
400 West King  
Kingsville, Texas 78363  
Office 361.595.8007  
Fax 361.595.8035

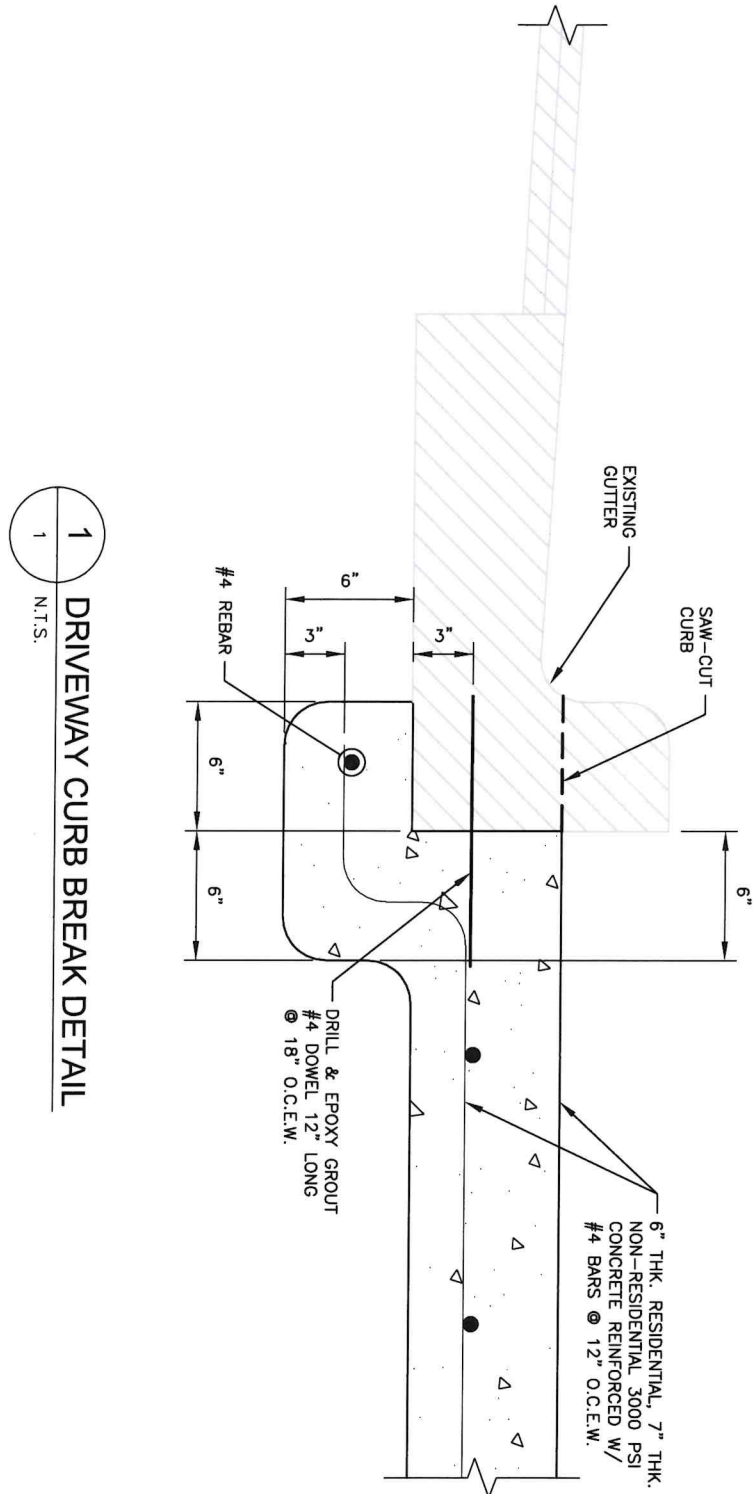

1 DRIVEWAY CURB BREAK DETAIL  
1 N.T.S.

REVISED  
05-31-2023

**CITY OF KINGSVILLE**  
**SIDEWALK DETAILS**

Drawn by: J. RAMIREZ  
Date: 04-12-2023  
Checked by: R. MORA  
Job:  
Scale: AS NOTED



CITY OF KINGSVILLE  
ENGINEERING DEPARTMENT  
400 West King  
Kingsville, Texas 78363  
Office 361.595.8007  
Fax 361.595.8035

SHEET  
1

DISCLAIMER: The use of this standard is governed by the "Texas Engineering Practice Act". No warranty of any kind is made by TxDOT for any purpose whatsoever. TxDOT assumes no responsibility for the conversion of this standard to other formats or for incorrect results or damages resulting from its use.

DATE:  
FILE:

TYPICAL CROSSING LAYOUTS  
SEE SHEET 1 OF 4 FOR DETAILS AND DIMENSIONS

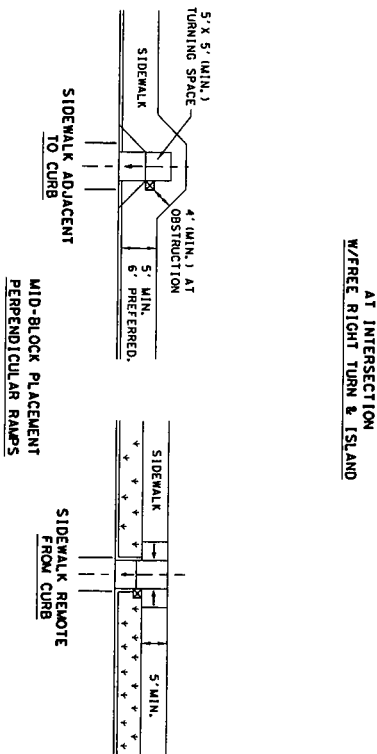
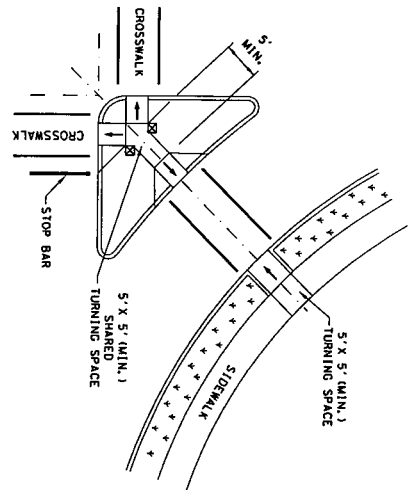
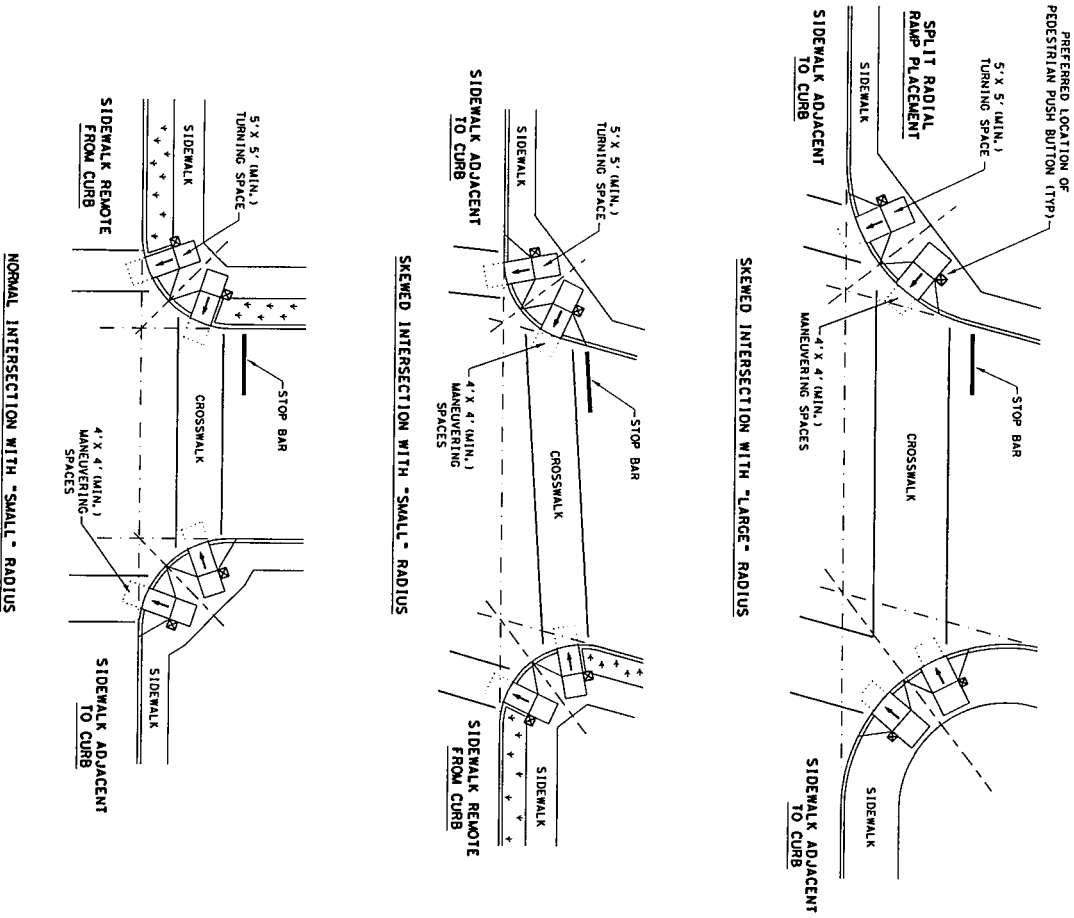

- LEGEND:**
- SHOWS DOWNWARD SLOPE.
  - ☒ DENOTES PREFERRED LOCATION OF PEDESTRIAN PUSH BUTTON (IF APPLICABLE).
  - ⊗ DENOTES PLANTING OR NON-WALKING SURFACE NOT PART OF PEDESTRIAN CIRCULATION PATH.

SHEET 4 OF 4

**PEDESTRIAN FACILITIES  
CURB RAMPS**

PED-18

FILED: 2003	DATE: 11/14/03	BY: [Signature]	DATE: 11/14/03
DESIGNED BY: [Signature]	CHECKED BY: [Signature]	DATE: 11/14/03	DATE: 11/14/03
REVISIONS:	NO.	DATE	DESCRIPTION
1			
2			
3			
4			
5			
6			
7			
8			
9			
10			
11			
12			
13			
14			
15			
16			
17			
18			
19			
20			
21			
22			
23			
24			
25			
26			
27			
28			
29			
30			
31			
32			
33			
34			
35			
36			
37			
38			
39			
40			
41			
42			
43			
44			
45			
46			
47			
48			
49			
50			







DISCLAIMER: The use of this standard is governed by the "Texas Engineering Practice Act". No warranty of any kind is made by TxDOT for any purpose whatsoever. TxDOT assumes no responsibility for the conversion of this standard to other formats or for incorrect results or damages resulting from its use.

DATE: \_\_\_\_\_  
FILE: \_\_\_\_\_

**SIDEWALK TREATMENT AT DRIVEWAYS**

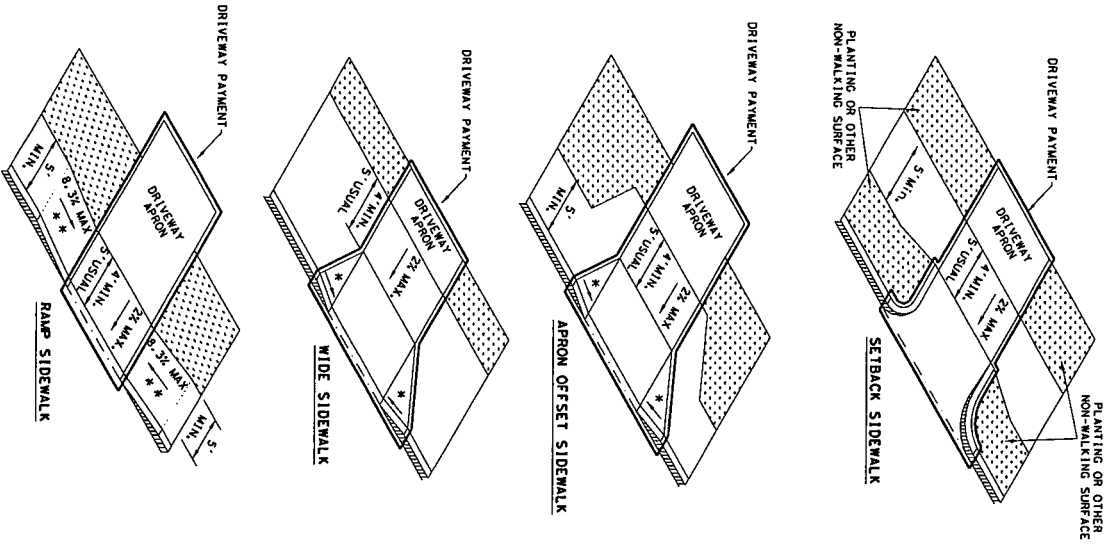

NOTES:  
\* WHERE DRIVEWAYS CROSS THE PEDESTRIAN ROUTE, SIDES SHALL BE FLARED AT 10% MAX SLOPE.  
\* IF CURB HEIGHT IS GREATER THAN 6 INCHES, USE GRADE LESS THAN OR EQUAL TO 5% HANDRAIL AND DETECTABLE WARNING ARE NOT REQUIRED.

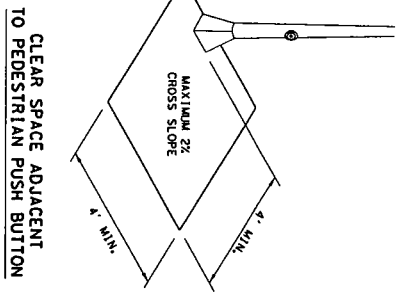
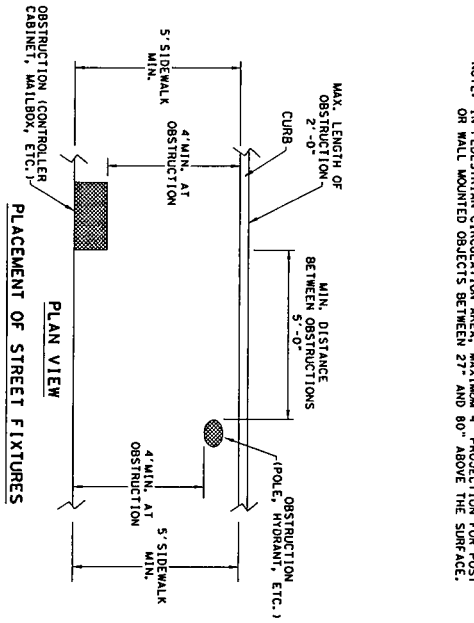
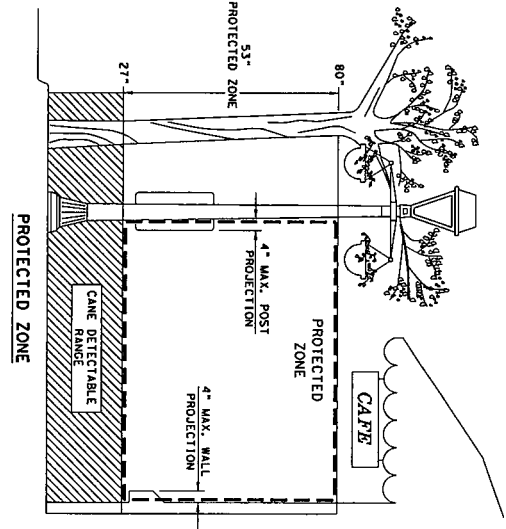

**CLEAR SPACE ADJACENT TO PEDESTRIAN PUSH BUTTON**

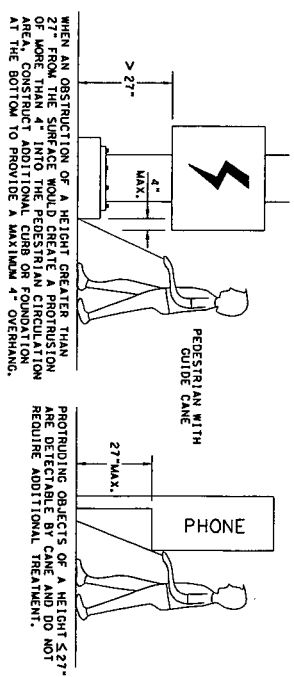

**DETECTION BARRIER FOR VERTICAL CLEARANCE < 80\"/>**

SHEET 3 OF 4

**PEDESTRIAN FACILITIES CURB RAMPS**

**PED-18**

FILE: PED-18	DATE: 03/18/2002	BY: TxDOT	CHKD: TxDOT	APP'D: TxDOT	DATE: 03/18/2002
PROJECT: PEDESTRIAN FACILITIES	PROJECT NO: 0000000000	CONTRACT NO: 0000000000	SECTION NO: 0000000000	SHEET NO: 0000000000	TOTAL SHEETS: 0000000000

# SAMPLE OF ACCEPTED DRAWINGS

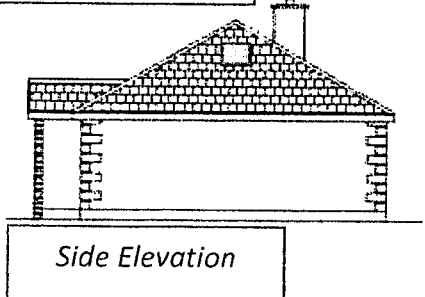
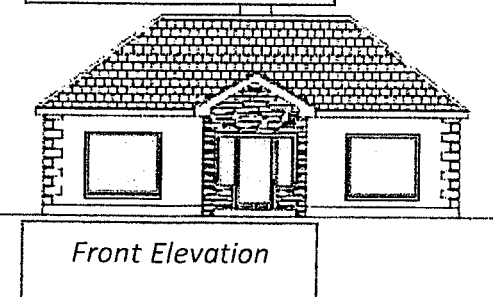
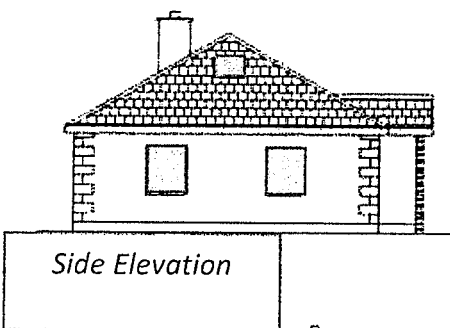
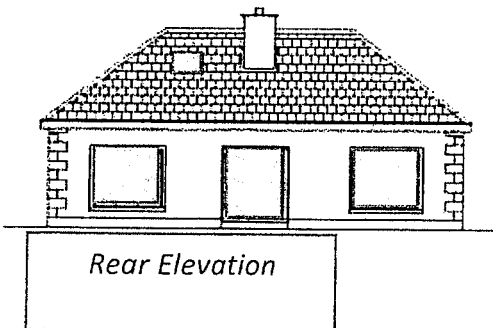
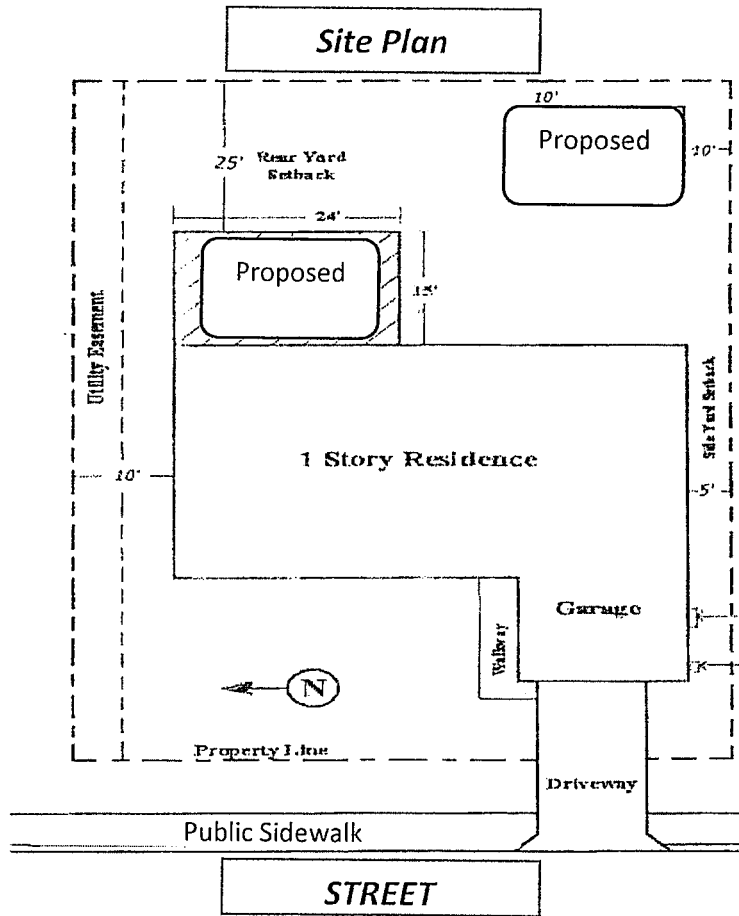

PART 2 - CODE OF ORDINANCES  
Chapter XV - LAND USAGE  
ARTICLE 8. LANDSCAPING POLICY

---

## **ARTICLE 8. LANDSCAPING POLICY**

### **Sec. 15-8-1. General.**

- (A) The information in this article is intended to define the technical design criteria needed to achieve the landscape policy goals of the City of Kingsville, Texas. These rules apply to all land located within the city limits and to those projects outside the city limits which have agreed to comply with these provisions as part of a contractual agreement with the city.
- (B) The site plan approval process is outlined in the City Code of Kingsville. Procedures for inspection and enforcement are also found in the City Code.
- (C) Appeals concerning the enforcement of these rules shall be brought to attention of the Director of Planning.  
(Ord. 97040, passed 11-24-97; Ord. 98027, passed 11-28-98; Ord. 2005-13, passed 4-11-05)

### **Sec. 15-8-2. Reserved.**

### **Sec. 15-8-3. Exemptions.**

(Reserved)

### **Sec. 15-8-4. Specified by the city code.**

The code identifies certain types of development projects which are specifically noted as being exempt from the Landscape Provisions of the Code, as follows, to wit:

- (A) Single family residences where only one such structure is constructed per lot.
- (B) Duplex residences (containing fewer than six bedrooms per lot) where only one structure is constructed per lot.
- (C) Restoration of damage to a structure within the 12 months subsequent to a fire, explosion, flood, tornado, riot or accident of any kind.
- (D) Building restoration for historic structures.
- (E) Remodeling of any structure where the front and side exterior walls remain in the same location. Two variations on this condition are illustrated in Figure 2-1.

(Ord. 97040, passed 11-24-97; Ord. 2005-13, passed 4-11-05)

### **Sec. 15-8-5. Not clarified by City Code.**

Other types of projects are exempt for other reasons. These include:

- (A) Projects on federal and state owned land.
- (B) Carports, canopies and free-standing covers supported by columns less than two feet wide and four feet long.

---

(Ord. 97040, passed 11-24-97; Ord. 2005-13, passed 4-11-05)

### **Sec. 15-8-6. Basic requirements.**

The following text explains the basic landscape requirements common to all commercial sites under the jurisdiction of the City Code.

(Ord. 97040, passed 11-24-97; Ord. 2005-13, passed 4-11-05)

### **Sec. 15-8-7. Street yard.**

(A) Landscape area.

- (1) At least 10% of street yard must be landscaped. Grass areas not using grasses indigenous listed on the Preferred Plant List (see Exhibit A) are not credited as landscaped area except in shaded areas (areas that receive less than six hours of sunlight per day).

(B) Determining street yard.

- (1) The exact configuration of a street yard (or street yards) on a site will depend on how a number of factors interrelate on that site. Among these factors are:
  - (a) Type and location of building walls.
  - (b) Number of streets that border the site.
  - (c) Number, size, and orientation of buildings on the site.
  - (d) Whether there is a building on the site or just a parking lot.
- (2) The street yard area is calculated by finding the total lot square footage which lies between the street right of way line and the front wall of a building or buildings on a site. This street yard boundary extends from the outward most corners of the front wall, parallel to the street until it intersects with the side property lines.
- (3) The building wall line shall include irregular shapes or indentions of the building wall, but exclude unenclosed porches, canopies and exterior columns. Some examples of variations on this concept are illustrated in Figure 2-2.
- (4) On a site or portion of a site used only for parking purposes or as a commercial or private parking lot, the street yard shall consist of the area between the street right-of-way and the back property line.

(C) Drip line credit.

- (1) In order to encourage the preservation and continued growth of smaller trees, the following credit toward landscape area is possible. Each square foot of landscape area which is permeable and within the area encompassed by the drip line of a surveyed tree at least two inches in trunk diameter measured at 4½ feet above the ground, shall count as 1.25 square feet of landscape area.
- (2) The foregoing credit shall be subject to the following limitations:
  - (a) Overlapping drip line area cannot be counted twice.
  - (b) No credit will be given if more than half of the drip line area is impervious.
  - (c) No credit will be given where damaging grade changes within the drip line (of a tree) has occurred.

- (d) In no case can the actual landscape area in the street yard of a lot be less than one-third of the required 10%.
- (D) Street yard trees. Within the area described as street yard in Section 11-12-71 a minimum amount of trees are required to be planted or preserved with at least 60% of the trees planted from the Preferred Plant List (see Exhibit A) to the area. Planted trees shall be no less than 6 feet initial height and no less than 1½ inch caliper measured at 4½ feet above the ground. No more than 50% of planted trees will be from the same genus or species (if more than ten trees are required), as follows:

TOTAL STREET YARD AREA	REQUIRED TREES
1,000—10,000 sq. ft.	1 tree/2,000 sq. ft.
10,000—110,000 sq. ft.	5 trees for first 10,000 sq. ft. plus 1 tree for every 5,000 sq. ft. over 10,000 sq. ft.
over 110,000 sq. ft.	25 trees for first 110,000 sq. ft. plus 1 tree for every 10,000 sq. ft. over 110,000 sq. ft.

- (E) Existing tree credit. All existing surveyed trees over two inches in trunk diameter or tree clusters of at least four one-inch diameter trees preserved within the street yard boundaries may satisfy these requirements one for one. All trees measuring six inches or more in trunk diameter measured at 4½ feet above the ground shall count double toward satisfying these requirements.

(Ord. 97040, passed 11-24-97; Ord. 98027, passed 12-28-98; Ord. 2005-13, passed 4-11-05)

**Sec. 15-8-8. Landscape in parking lots.**

- (A) Landscape area.
  - (1) Four square feet of landscaped area is required for each parking space within a parking lot located in the street yard. Three square feet for each parking space is required for all non-street yard parking lots.
  - (2) This landscape area should occur entirely within the parking lot boundaries as landscaped medians, landscaped islands or as landscaped peninsulas.
- (B) Islands, medians or peninsulas.
  - (1) A landscape island, median or peninsula should be located within 100 feet of each entire parking space on a lot. This distance should be measured from the curb line of the landscape island, median, or peninsula and should extend 1 foot into the entire parking space.
  - (2) Grasses not listed on the Preferred Plant List (see Exhibit A) cannot be planted on islands, medians, or peninsulas. At least 60% of the required landscape area must be selected from the Preferred Plant List (see Exhibit A) with no more than 50% of the plants from the species.
  - (3) To provide significant space for the growth of trees planted within these areas, the minimum width for landscaped islands, medians, or peninsulas which contain new trees is eight feet measured from the inside of the curb (see Figure 2-3).
- (C) Trees in parking lots. One tree must be located within 100 feet of each parking space. This requirement should also be considered when designating parking lot landscape area (see Figure 2-4).
- (D) Special provisions for large parking lots. The above paragraphs (B)(1) and (C), in Section 15-8-8, do not apply if this division (D) is required. For parking lots with more than three parking modules, a ten feet minimum width median (measured from inside of curb) will be required for every third parking module. Trees within the median must be located so that one tree shall be located within 50 feet of each parking space adjacent to

---

the median. No additional islands shall be required to satisfy Section 15-8-8 except for end islands for each parking module (see Figure 2-4.1). All landscape islands and peninsulas must be an eight feet minimum width measured from inside of curb.

(Ord. 97040, passed 11-24-97; Ord. 98027, passed 12-28-98; Ord. 2005-13, passed 4-11-05)

### **Sec. 15-8-9. Buffering/screening.**

- (A) Buffering is a site specific requirement that should be evaluated based on viewer distance and angle of view from the areas or site features requiring buffering. Buffer design should also consider the amount of view obstruction required and the type and mixture of design elements used in the buffer. Buffering is a site specific requirement that shall be between all multi-family (R-3 and above) and commercial and industrial land uses.
- (B) When buffering is required, the installation and maintenance thereafter of a visual screen of one of the following types shall be provided:
- (1) A solid material and/or masonry fence or wall at least six feet in height.
  - (2) A hedge-like screen of evergreen plant material capable of attaining a minimum height of six feet at maturity, planted initially at a minimum of four feet on center. The plants will be a minimum height of two and one-half feet at time of planting. An irrigation system shall also be installed.
  - (3) Existing vegetation may be used as screening if the following conditions are met:
    - (a) The vegetation area is at least ten feet wide and a limit of construction line is clearly marked on the plans.
    - (b) The area must contain, per 20 linear feet of screen, the equivalent of one large tree (minimum two inch caliper), two small trees (minimum one inch caliper) and six evergreen plants at a minimum height of two and one-half feet with the minimum height attainment at maturity of at least six feet. If an irrigation system is not in place, one must be installed.

(Ord. 97040, passed 11-24-97; Ord. 98027, passed 12-28-98; Ord. 2005-13, passed 4-11-05; Ord. 2006-10, passed 4-10-06)

### **Sec. 15-8-10. Landscape of other areas.**

Landscape of other areas shall include all landscaped areas that are not included as part of the Street Yard, Parking Lots or Buffering requirements.

- (A) Plant selection. At least 90% of the areas shall be planted with species from the Preferred Plant List (See Exhibit A). Up to 10% of the plants may be of a non-preferred variety as long as they are grouped together in a suitable area and can be irrigated separately.
- (B) Turf selection. Areas that receive more than six hours of sunlight per day shall be planted with turf species from the Preferred Plant List (see Exhibit A).

(Ord. 97040, passed 11-24-97; Ord. 2005-13, passed 4-11-05)

### **Sec. 15-8-11. Soil conditioning and mulching.**

- (A) A minimum of three inches of organic mulch shall be added in non-turf areas to the soil surface after planting.

- 
- (B) Non-porous material such as sheet plastic shall not be placed under the mulch.
  - (C) A minimum of four inch permeable soil, native or imported, shall be required for turf and landscaped areas.  
(Ord. 97040, passed 11-24-97; Ord. 2005-13, passed 4-11-05)

### **Sec. 15-8-12. Irrigation of landscape areas.**

- (A) The owner shall be responsible for the irrigation of all required landscape areas and plant materials, utilizing one or a combination of the following methods:
  - (1) An automatic or manual underground irrigation system (conventional spray, bubblers, drip, emitters, drip tubing, porous pipe and the like with tuft zones separated from planting zones unless otherwise approved;
  - (2) A hose attachment within 100 feet of all required landscape areas and plant materials where there is no road or parking pavement between the hose attachment and landscape area and the site plan area is no larger than 0.5 acre;
  - (3) Landscape areas planted with native grasses and wild flowers may use a temporary and above ground irrigation system and shall be required to provide irrigation only for the first two growing seasons.
- (B) The irrigation methods used shall:
  - (1) Be in place and operational at the time of the landscape inspection; and
  - (2) Be maintained and kept operational at all times to provide for efficient water distribution;
  - (3) Landscape working plans shall indicate, by a detail, a drawing or by specification in a note on the site plan, the nature and location of irrigation which will be used and the location of emergency irrigation system shut-off valve;
  - (4) No irrigation shall be required for undisturbed natural areas or undisturbed existing trees.

(Ord. 97040, passed 11-24-97; Ord. 98027, passed 12-28-98; Ord. 2005-13, passed 4-11-05)

### **Sec. 15-8-13. Protection of landscape area.**

- (A) All landscape areas adjacent to vehicular use areas shall be protected with concrete curbs or equivalent barriers.
- (B) An equivalent barrier must be at least six inches in height and anchored sufficiently to prevent movement. Examples of alternatives are listed below:
  - (1) Equivalent barriers:
    - (a) Asphalt curbs.
    - (b) Railroad ties (anchored).
    - (c) Rock or stone curbs (anchored).
    - (d) Bollards located with a distance between each not to exceed four feet six inches measured from the outside surface of the bollard.
    - (e) Wheelstops (anchored).

(Ord. 97040, passed 11-24-97; Ord. 2005-13, passed 4-11-05)



**Sec. 15-8-14. Alternative compliance.**

- (A) The Director of Planning may accept alternative designs which prove to be as good or better than strict compliance with the basic landscape requirements.
- (B) Alternative proposals should be clearly identified on the landscape plans and the Building Permit application should include a letter outlining the alternative proposal. (See Exhibit C.) Review of the alternative proposal will be in conjunction with the Building Permit review.
- (C) To establish some guideline equivalents for the major landscape requirements listed in §§ 15-8-6 through 15-8-10, a list of alternative equivalent ratings are found below. These ratings assign relative values to the landscape elements of a design and should be used when formulating alternative proposals. Each basic requirement which cannot be achieved is assigned a negative point value and may be compensated for with positive equivalents shown in the compensation list. An example using this concept is provided in Figure 2-7.
- (D) These ratings are intended to provide guidance for proposing alternatives to strict compliance for unusual site specific conditions. However, other proposed equivalents may be accepted based on extremely unusual conditions, if approved by the Director of Planning.

*ALTERNATIVE COMPLIANCE EQUIVALENT RATINGS  
Deficiencies*

The following information should be used to formulate alternative proposals when a site design cannot conform to the basic landscape requirements as described in § 15-8-6:

Landscape Area as a Percent of Street Yard	Negative Points
<5%	- 12
5%	- 10
6%	- 8
7%	- 6
8%	- 4
9%	- 2
10%	- 0

Landscape Area for Each 12 Parking Spaces	Negative Points
<3 square feet	- 6
3 square feet	- 3
4 square feet	- 0

Landscape Islands, Medians Peninsula Placement	Negative Points
Within 150 feet of each space	- 6
Within 125 feet of each space	- 3
Within 100 feet of each space	- 0

Trees Installed in Parking Landscape Areas	Negative Points

Within 150 feet of each space	- 6
Within 125 feet of each space	- 3
Within 100 feet of each space	- 0

Alternative Compliance Equivalent Ratings		
Trees		Positive Points
Percent of Installed Street Yard Trees (all must be from) Preferred Plant List (see Exhibit A)		3" or greater caliper
10%		2 pts.
20%		4 pts.
30%		6 pts.
40%		8 pts.
50% and greater		10 pts.
Buffer		1 pt.
Buffer Increased Above Minimum		2 pts.
10%		3 pts.
20%		4 pts.
30%		5 pts.
40%		
50%		
Special Landscape Features		
**Arbors, gazebos or shade seating areas for public benefit		+10
*Approved rain water storage and irrigation distribution systems		+10
Native Plant Credit		+10
*All native plant materials		

(Ord. 97040, passed 11-24-97; Ord. 98027, passed 12-28-98; Ord. 2005-13, passed 4-11-05)

**Sec. 15-8-15. Screening standards.**

A screening device is required between all R-1/R-2 residential land use/zoning and all types of multi-family (R-3 and above), commercial and industrial land use/zoning. Screening is also required between R-1/R-2 residential land use/zoning and all mobile home zoning land use/zoning.

(Ord. 2006-10, passed 4-10-06)

**Sec. 15-8-16. General.**

When screening is required, the installation and maintenance thereafter of a visual screen shall be provided consisting of a solid material and/or masonry fence or wall at least six feet in height which cannot be seen through.

(Ord. 97040, passed 11-24-97; Ord. 2005-13, passed 4-11-05; Ord. 2006-10, passed 4-10-06)

**Sec. 15-8-17. Certificate of occupancy.**

Landscaping. required in this section must be in place prior to obtaining a Certificate of Occupancy.

(Ord. 97040, passed 11-24-97; Ord. 2005-13, passed 4-11-05)

**Sec. 15-8-18. Violations; penalties.**

- (A) It shall be unlawful to construct, reconstruct, remove or relocate any landscaped area or other appurtenance in violation of the provisions of this article; and proper city officials, or their duly authorized representatives, in addition to other remedies, may institute any appropriate action or proceedings to prevent such unlawful construction, reconstruction, removal or relocation, to restrain, correct or abate such violations, to prevent any illegal act, conduct business or maintenance in and about such premises. Each day such violation continues shall constitute a separate violation.
- (B) Any person violating any provision of this article shall be guilty of a misdemeanor, and each shall be deemed guilty of a separate offense for each day or portion thereof during which any violation hereof is committed, continued or permitted, and upon conviction any such violation shall be punishable by a fine not to exceed \$500.00.

(Ord. 97040, passed 11-24-97; Ord. 2005-13, passed 4-11-05)

**EXHIBIT A. PREFERRED PLANT LIST**

Other plants may be used if approved by the city. This list is a guide and is not meant to be exclusive. Any other native or well adapted plant may be used if drawings are sealed by a registered Texas Landscape Architect.

Evergreen Trees	Height	Features (N = Native)
Arizona Cypress <i>Cupressus arizonica</i>	30'—75'	good heat and drought tolerance, aromatic foliage
Cherry Laurel <i>Prunus caroliniana</i>	25'—30'	N, screening plant, wildlife food
Deodar Cedar <i>Cedrus deodara</i>	40'—50'	fine texture, needs drainage
Live Oak <i>Quercus virginiana</i>	50'—60'	N, oak wilt susceptible
Mountain Laurel <i>Sophora secundiflora</i>	15'—25'	N, fragrant purple spring blossoms, small tree, large shrub
Texas Madrone <i>Arbutus texana</i>	25'—30'	N, distinctive, attractive bark, difficult to propagate and transplant
Yaupon Holly <i>Ilex vomitoria</i>	15'—20'	N, red berries in winter, small tree, large shrub

Deciduous Trees	Height	Features (N = Native)
American Elm <i>Ulmus americana</i>	60'—80'	N, vase-shaped canopy, susceptible to Dutch Elm disease
Bald Cypress <i>Taxodium distichum</i>	60'—70'	N, fine texture, rust fall color
Bradford Pear <i>Pyrus calleryana 'Bradford'</i>	30'—40'	showing white spring flowers

Bur Oak <i>Quercus muehlenbergii</i>	60'—100'	N, large fringed acorn, majestic, adaptable tree
Cedar Elm <i>Ulmus crassifolia</i>	50'—60'	N, fall color, small leaves
Chinese Pistache <i>Pistacia chinensis</i>	30'—40'	brilliant fall color, very adaptable
Chinquapin Oak <i>Quercus Muhlenbergii</i>	40'—60'	N, tall, slender form, dark glossy lush foliage
Crape Myrtle* <i>Lagerstroemia indica</i>	25'—30'	summer flowers, many varieties
Desert Willow <i>Chilopsis linearis</i>	15'—25'	N, orchid-like blooms, not a true willow
Drake Elm <i>Ulmus parvifolia</i> 'Drake'	20'—30'	nearly evergreen, drought tolerant
Fragrant Ash <i>Fraxinus cuspidata</i>	10'—12'	N, fragrant white flowers in late spring
Golden Rain Tree <i>Koelreuteria bipinnata</i> * and <i>K. paniculata</i>	20'—30'	yellow spring blooms, drought tolerant
Honey Mesquite <i>Prosopis glandulosa</i>	25'—30'	N, drought tolerant, wood valued for smoking meat
Mexican Plumb <i>Prunus mexicana</i>	15'—25'	N, white spring blossoms, wildlife food
Orchid Tree <i>Bauhinia</i> spp.	6'—12'	N, showy white blossoms, small understory or patio tree
Pecan <i>Carya illinoensis</i>	60'—80'	N, shade tree, nut producing
Shumard Oak <i>Quercus shumardii</i>	50'—75'	N, fast growing, good fall red foliage coloration, very tolerant of limestone soils
Texas Ash <i>Fraxinus texensis</i>	40'—50'	N, fast growing, shade tree, exceptional fall foliage coloration
Texas Persimmon <i>Diospyros texana</i>	15'—20'	N, wildlife food, multi-trunk
Texas Redbud <i>Cercis Canadensis</i> var. 'Texensis'	20'—25'	N, early pink-blossoms, drought tolerant
Texas Red Oak <i>Quercus texana</i>	30'—40'	N, white patches on bark, fall color
Vitex, Lilac Tree <i>Vitex Agnus-castus</i>	15'—20'	late spring lavender blossoms, small tree
Western Soapberry <i>Sapindus Drummondii</i>	30'—40'	N, showy winter fruit, yellow fall color
*susceptible to severe freeze		

Evergreen Shrubs	Sun	Shade	Features (N = Native)
Agarita <i>Berberis trifoliolata</i>	o		N, prickly leaves, bright red berries
Barbados Cherry* <i>Malpighia glabra</i>	o	o	N, pale pink flowers, berries attract wildlife

Burford Holly <i>Ilex cornuta</i> 'Burfordii'	o	o	glossy dark green foliage, red fruit
Dwarf Burford Holly <i>Ilex cornuta</i> 'Burfordii nana'	o	o	glossy leaves, berries not prominent
Dwarf Chinese Holly <i>Ilex cornuta</i> 'Rotunda nana'	o	o	spiny foliage, no berries
Dwarf Yaupon Holly <i>Ilex vomitoria</i> 'Nana'	o	o	low mound-like shrub, no berries
Elaeagnus <i>Elaeagnus pungens</i>	o	o	silver foliage, fragrant white fall flowers
Mountain Laurel <i>Sophora secundiflora</i>	o	o	N, showy fragrant purple flower, large shrub
Nandina <i>Nandina domestica</i>	o	o	red berries, red fall, winter color
Oleander* <i>Nerium oleander</i>	o		summer flowers, large shrub
Pampas Grass* <i>Cortaderia selloana</i>	o		large, clumping grass
Red Yucca <i>Hesperaloe parviflora</i>	o		N, coral flower spike, not a true yucca
Rosemary* <i>Rosmarinus officinalis</i>	o		aromatic leaves, 'Prostratus' cultivar
Shore Juniper <i>Juniperus conferta</i>	o		spreading, ground cover, blue-green
Texas Sage <i>Leucophyllum frutescens</i>	o		N, lavender flowers, gray or green foliage
Texas Sotol <i>Dasyliirion texanum</i>	o		N, long blade-like leaf with spines
Wax Myrtle <i>Myrica cerifera</i>	o	o	N, very adaptable, aromatic leaves, berries used for Bayberry fragrance

Semi-Evergreen Shrubs**	Sun	Shade	Features (N = Native)
Cast Iron Plant** <i>Aspidistra elatior</i>		o	broad strap shaped leaves to 2 inches height
Glossy Abelia <i>Abelia grandiflora</i>	o		small pink flowers, glossy leaves
Muhly Grass <i>Muhlenbergia lindheimeri</i>	o		N, looks like small pampas grass
Pineapple Guava* <i>Feijoa sellowiana</i>	o		exotic fragrant flowers
Pomegranate* <i>Punica granatum</i>	o	o	orange flowers, yellow fall flowers
Primrose Jasmine <i>Jasminum mesnyi</i>	o		yellow flowers, mounding form
* susceptible to severe freeze			
** influenced by severity or duration of winter			

Deciduous Shrubs	Sun	Shade	Features (N = Native)
Althaea Hibiscus syriacus	o		showy summer flowers
Butterfly Bush Buddleia Davidii	o		N, lavender/lilac flowers, small fuzzy leaves
Flame Acanthus Anisacanthus Wrightii	o	o	N, orange flowers attracts hummingbirds
Texas Lantana* Lantana horrida and L. camara	o		N, good summer color, many varieties
Trailing Lantana* Lantana montevidensis	o	o	N, lilac colored flowers, summer through fall
*susceptible to severe freeze			

Evergreen Vines & Groundcovers	Sun	Shade	Features (N = Native)
Asian Jasmine* Trachelospermum asiaticum	o	o	low vigorous ground-cover
Bigleaf Periwinkle Vinca major		o	loose ground-cover, blue flowers
Carolina Jessamine Gelsemium sempervirens	o	o	N, fragrant yellow flowers in spring
Coral Honeysuckle Lonicera sempervirens	o	o	N, coral flowers, red fruit, attract wildlife
Crossvine Bignonia capreolata	o	o	N, yellow/red flowers, clinging vine
Damianita Chrysactinia mexicana	o		N, yellow flowers, low growing to 12" height
English Ivy Hedera helix		o	clinging, vigorous, self-climbing vine
Fig Vine* Ficus pumila	o	o	clinging vine, fine texture
Lady Banks' Rose Rosa banksiae	o		yellow spring flowers, large cascading form
Big Blue Lilyturf Liriope muscari		o	purple spike flowers, clump-like foliage
Dwarf Periwinkle Vinca minor		o	blue flowers, ground-cover
Monkey Grass Ophiopogon japonicus		o	tufted grass-like ground-cover
Oregano Origanum vulgare	o	o	perennial, spreading herb
Stonecrop Sedum spp.	o	o	low, fast growing ground-cover
*susceptible to severe freeze			

Deciduous Vines & Groundcovers	Sun	Shade	Features (N = Native)
Bush Morning Glory Ipomoea leptophylla	o	o	N, forms 1-1/2'—3' mounds of foliage, lavender to purple flowers

Coral Vine Anigonon leptopus	o		pink flowers in summer and fall
Gregg Dalea* Dalea greggii	o	o	N, purple flowers in fall, ground-cover
Passion Vine* Passiflora incarnata	o	o	N, lavender flowers, edible fruit: Maypop
Trumpet Vine Campsis radicans	o	o	N, orange-scarlet flowers, invasive
Virginia Creeper* Parthenocissus quinquefolia	o	o	N, red fall color, clinging vine
*susceptible to severe freeze			

Flowering Perennials	Sun	Shade	Features (N = Native)
Silver Wormwood Artemisia ludoviciana	o		N, aromatic foliage, white fuzzy leaves
Black-eyed Susan Rudbeckia hirta	o	o	N, yellow dark-centered daisy, flowers May to September
Blackfoot Daisy Melampodium leucanthum	o		N, short white daisy flowers all summer, short lived
Butterfly Weed Asclepias tuberosa	o	o	N, orange/yellow flowers, attracts butterflies
Canna Lily Canna X generalis	o		banana-like foilage, blooms in summer
Cedar Sage Salvia roemeriana		o	N, red flowers, naturalizes
Cherry Sage Salvia greggii	o	o	N, red, pink, or white flowers
Cigar Plant Cuphea micropetala	o		orange-yellow fall flowers
Coreopsis Coreopsis lanceolata	o		N, yellow spring and fall flowers, clumping
Daylily Hemerocallis fulva	o		orange/yellow funnel-shaped flower
Fall Aster Symphyotrichum oblongifolium	o	o	N, blue/purple autumn flowers
Firebush* Hamelia patens	o		red-orange flowers, red fall color
Gayfeather Liatris spp.	o		N, purple flower spikes in autumn
Heartleaf Hibiscus Hibiscus cardiophyllus	o	o	N, red flowers all summer
Hymenoxys Hymenoxys scaposa	o		N, small yellow daisy, bitter smelling leaves
Maximilian Sunflower Helianthus maximiliana	o		N, yellow flower, late summer to fall
Mealy Blue Sage Salvia farinacea	o		N, blue flower spikes, spring and summer

Mexican Bush Sage Salvia leucantha	o		tall purple flower spikes
Mexican Heather* Cuphea hyssopifolia	o		tiny purple, pink or white flowers
Mexican Marigold Mint Tagetes lucida	o	o	yellow fall flowers, anise flavored foliage
Mexican Oregano Lippia graveolens	o		lavender/pink flowers, aromatic
Oxeye Daisy Chrysanthemum leucanthemum	o		white early summer flowers, yellow center
Peruvian Verbena* Verbena peruviana	o	o	pink flowers in summer, low growing
Pink Skullcap Scutellaria suffrutescens	o	o	pink flowers in summer, low growing
Plumbago* Plumbago auriculata	o	o	low growing, blue flowers
Purple Coneflower Echinacea purpurea	o	o	N, purple daisy-like flowers
Rose Mallow Pavonia lasiopetala	o	o	N, pink hibiscus-like flowers
Scarlet Sage Salvia coccinea	o	o	N, red, pink or white flowers, spring to fall
Spiderwort Tradescantia x Andersoniana		o	N, purple-blue flowers, informal ground cover
Turk's Cap Malvaviscus arboreus 'Drummondii'	o	o	N, red flowers and fruit, colonizing
White Mistflower Eupatorium Wrightii	o	o	N, white autumn flowers, attracts butterflies
Wild Petunia Ruellia nudiflora		o	N, purple flowers from March to December
Zexmenia Wedelia hispida	o	o	N, orange/yellow flowers, May to November
*susceptible to severe freeze			

Turf & Low Grasses	Sun	Shade	Features (N = Native)
Bermuda Cynodon dactylon	o		seed or hybrid sod
Blue Grama Bouteloua gracilis	o		N, seed, fine-leaf tufted grass, good meadow grass, not for mowed lawns
Buffalograss Buchloe dactyloides	o		N, many seed varieties, sod available in '609' and Prairie hybrids
Little Bluestem Schizachyrium scoparium	o		N, seed, blue-green, fine texture, not for mowed lawns

(Ord. 2014-45, passed 8-11-2014)

**EXHIBIT B. LANDSCAPE/IRRIGATION NOTES**



---

SITE DEVELOPMENT PERMIT - IRRIGATION NOTES

Automatic irrigation systems shall comply with the following guidelines. These guidelines (No. 1—No. 7) shall be noted on the Site Development Permit and shall be implemented as part of the landscape inspection.

1. Adjustable flow controls shall be required on circuit remote control valves and pressure regulation component(s) shall be required where static pressure exceeds manufacturer's recommended operating range.
2. Valve and circuits shall be separated based on water use, so that turf areas can be watered separately from shrub and ground cover areas.
3. Sprinkler heads shall have matched precipitation rates within each control valve circuit.
4. Serviceable check valves shall be required where elevation differential may cause low head drainage, adjacent to paving areas.
5. Sprinkler head spacing shall be designed for head-to-head coverage or heads shall be spaced as per manufacturer's recommendations and adjusted for prevailing winds. The system shall be designed for minimum run-off and minimum over-spray onto non-irrigated areas, (i.e. paving and structures).
6. All automatic irrigation systems shall be equipped with a controller capable of dual or multiple programming. Controllers shall have multiple cycle start capacity and a flexible calendar program, including the capability of being set to water every five days. All automatic irrigation systems shall be equipped with a rain sensor shut-off device.
7. Irrigation construction plans shall include a water budget. A laminated copy of the water budget shall be permanently installed inside the irrigation controller door. Water budget shall include:
  - a. Estimated monthly water use (in gallons per application) and the area (in square feet) irrigated.
  - b. Precipitation rates for each valve circuit.
  - c. Monthly irrigation schedule for the plant establishment period (first three months) and recommended yearly watering schedule, including seasonal adjustments.
  - d. Location of emergency irrigation system shut-off valve.

**EXHIBIT C. SAMPLE ALTERNATIVE COMPLIANCE LETTER**

PROJECT NAME:

PROJECT ADDRESS:

DATE:

NAME OF OWNER:

ADDRESS OF OWNER:

ADDRESS LETTER TO:

NAME OF DIRECTOR:

;hg;Director of Planning  
City of Kingsville  
200 E. Kleberg  
Kingsville, TX 78363

INCLUDE IN THE LETTER:

The body of the letter should state specifically in what way the project will not comply with the Landscaping Regulations and explain in detail how the alternative compliance proposal is "as good or better" than strict compliance as required.

The letter should also include the following:

1. The size, type and spacing of plant materials installed as part of the alternative compliance proposal.
2. The ordinance section numbers that the project is not complying with.
3. The contact person and the phone number where they can be reached during working hours.
4. The signature of the owner and agent.

(Ord. 2005-13, passed 4-11-05)

**EXHIBIT D. FIGURES**

Figure 2-1

NEW ADDITION

More than 1,000 Sq. Ft. but does not affect Street Yard

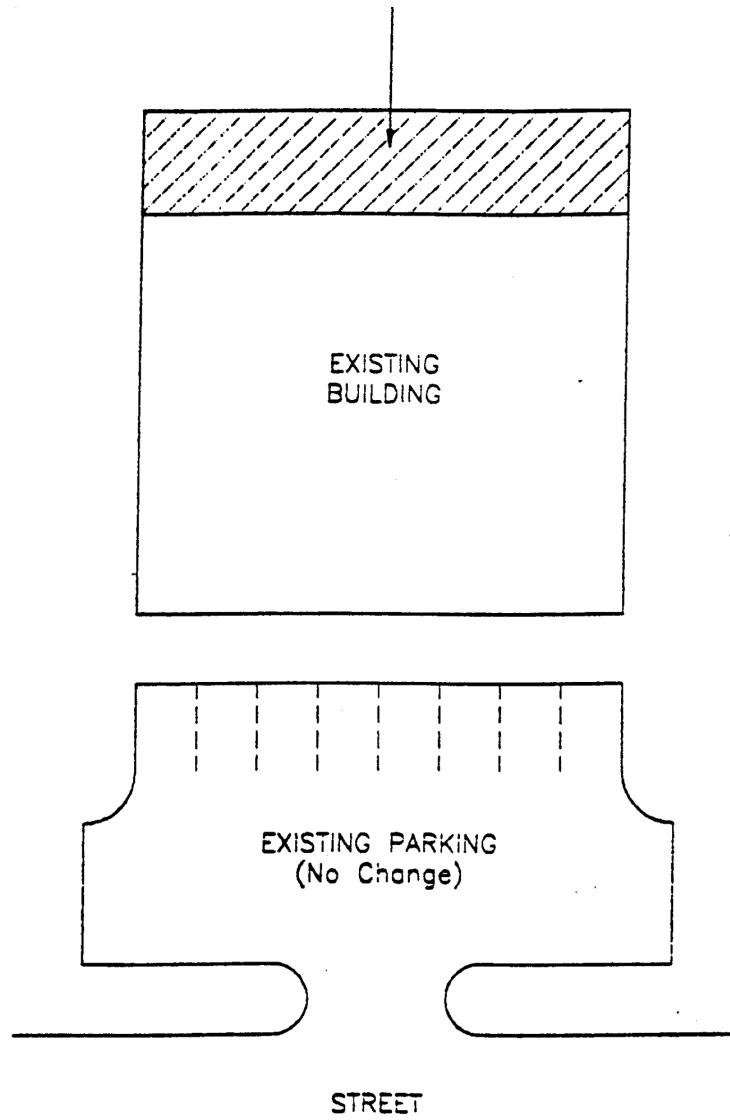

Exempt Projects

Figure 2-1  
NEW ADDITION

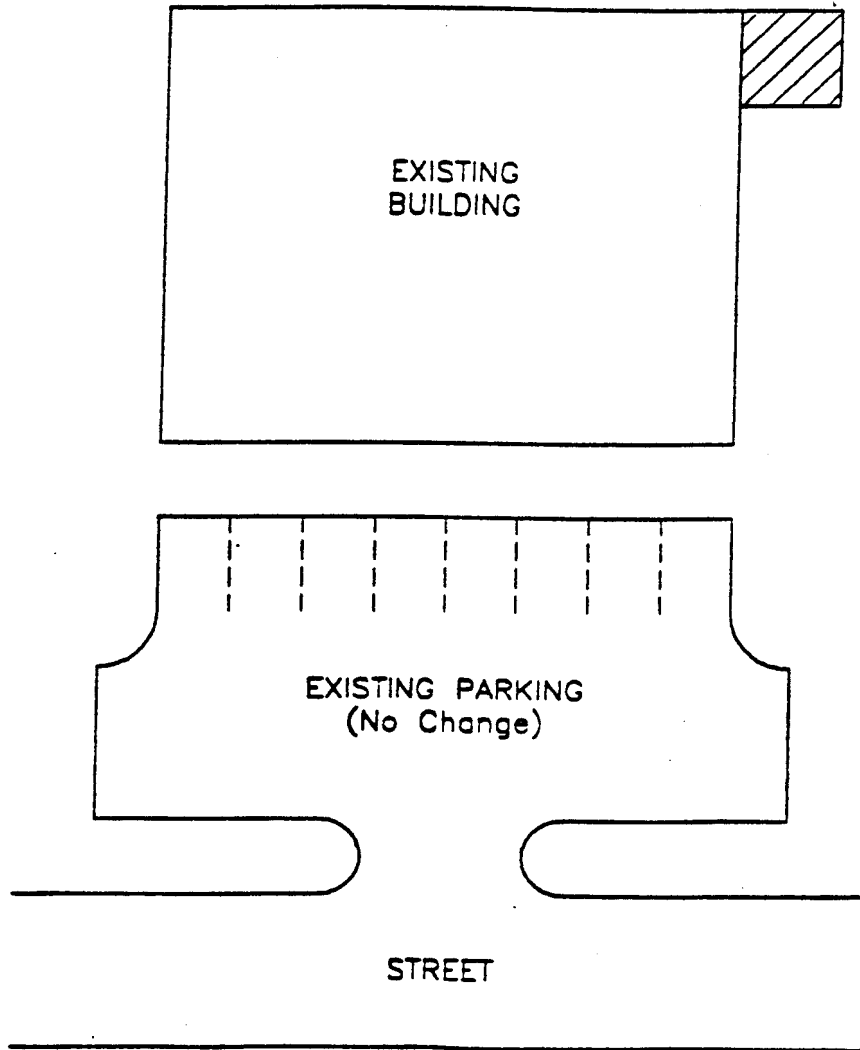

Exempt Projects (Continued)

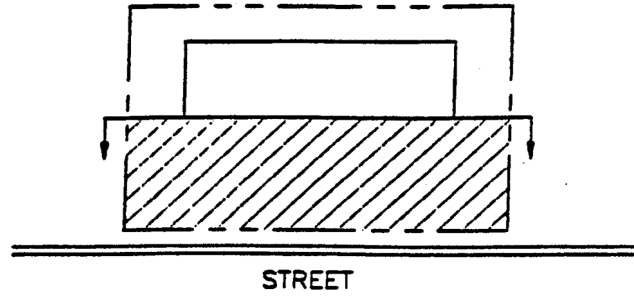

TYPICAL BUILDING

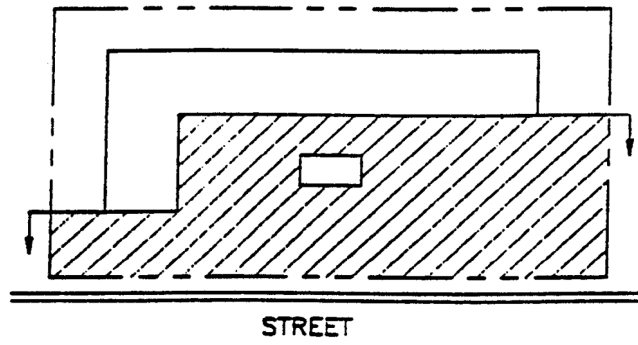

ISOLATED BUILDING

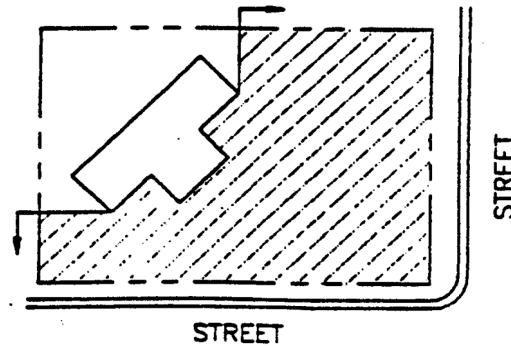

CORNER LOT

Street Yard Configurations

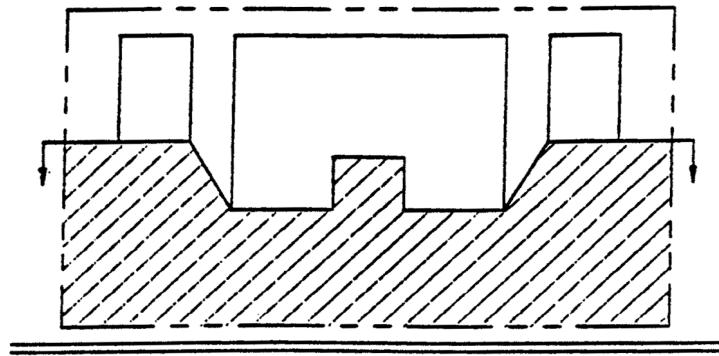

STREET  
RECESSED WALLS - FRONT BUILDING

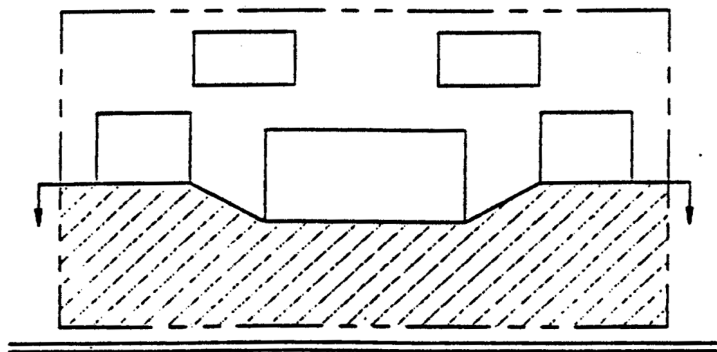

STREET  
RECESSED BUILDING

Street Yard Configurations (Continued)

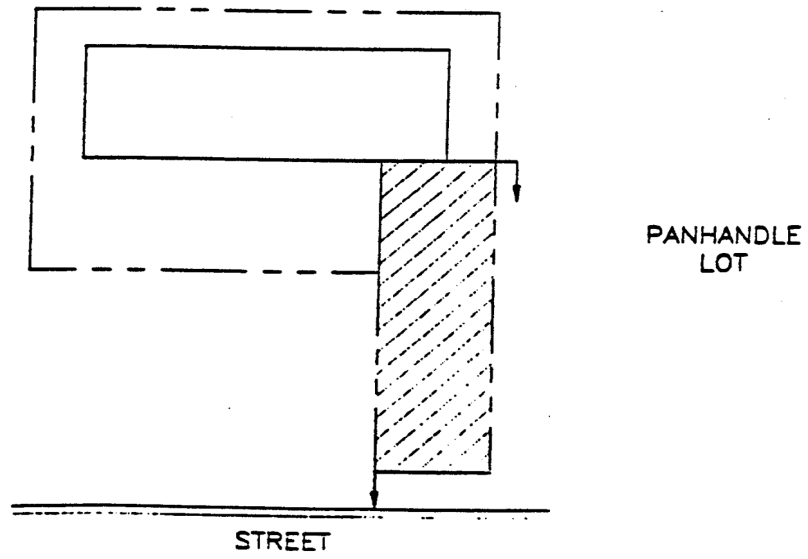
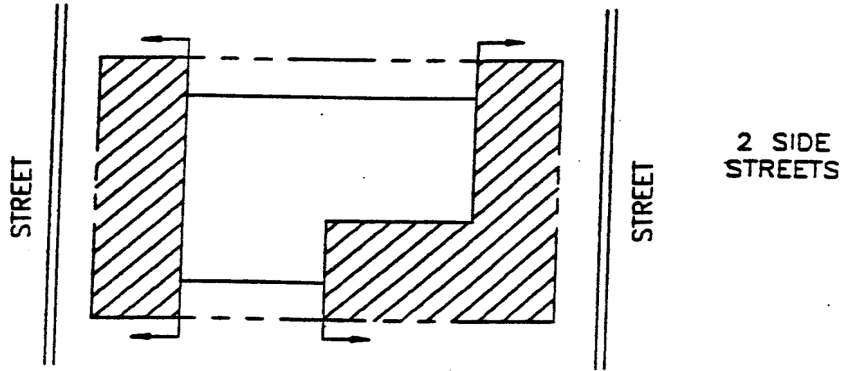

Street Yard Configurations (Continued)

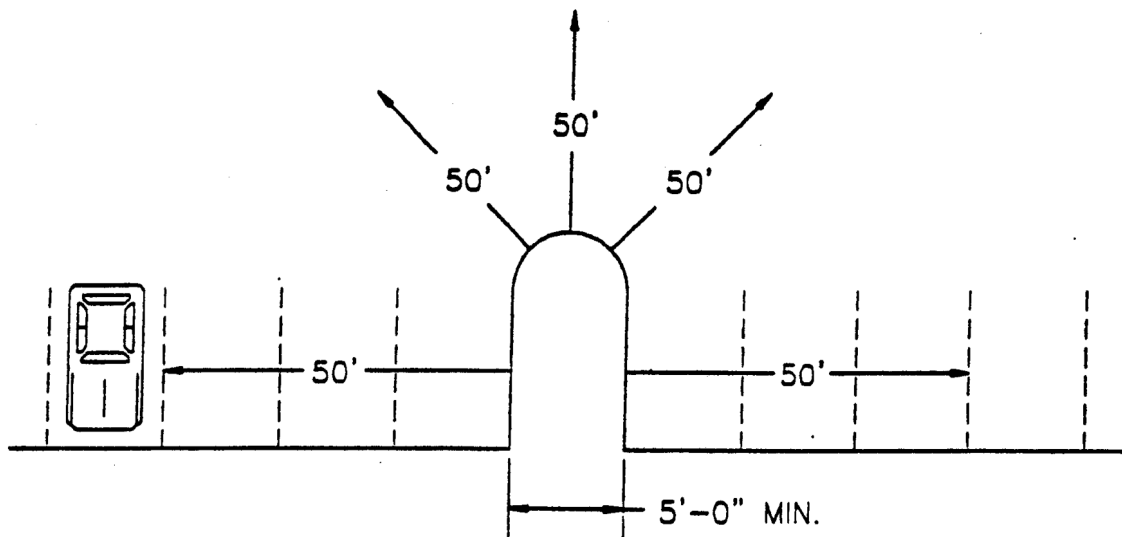

50 FOOT REQUIREMENT

PENINSULAS

Peninsula Placement (50 Foot Requirement)



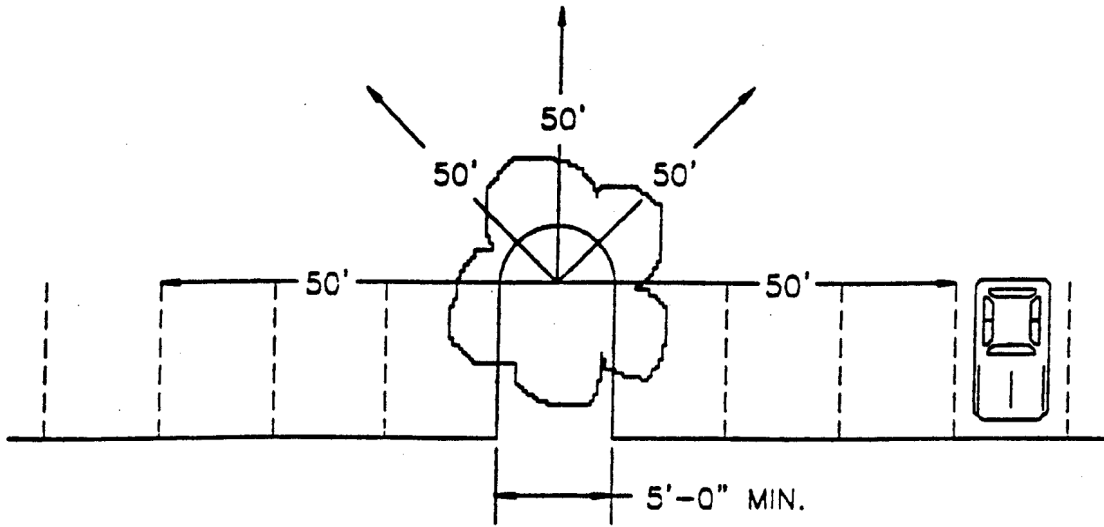

**50 FOOT REQUIREMENT**

**TREES**

Tree Placement (50 Foot Requirement)

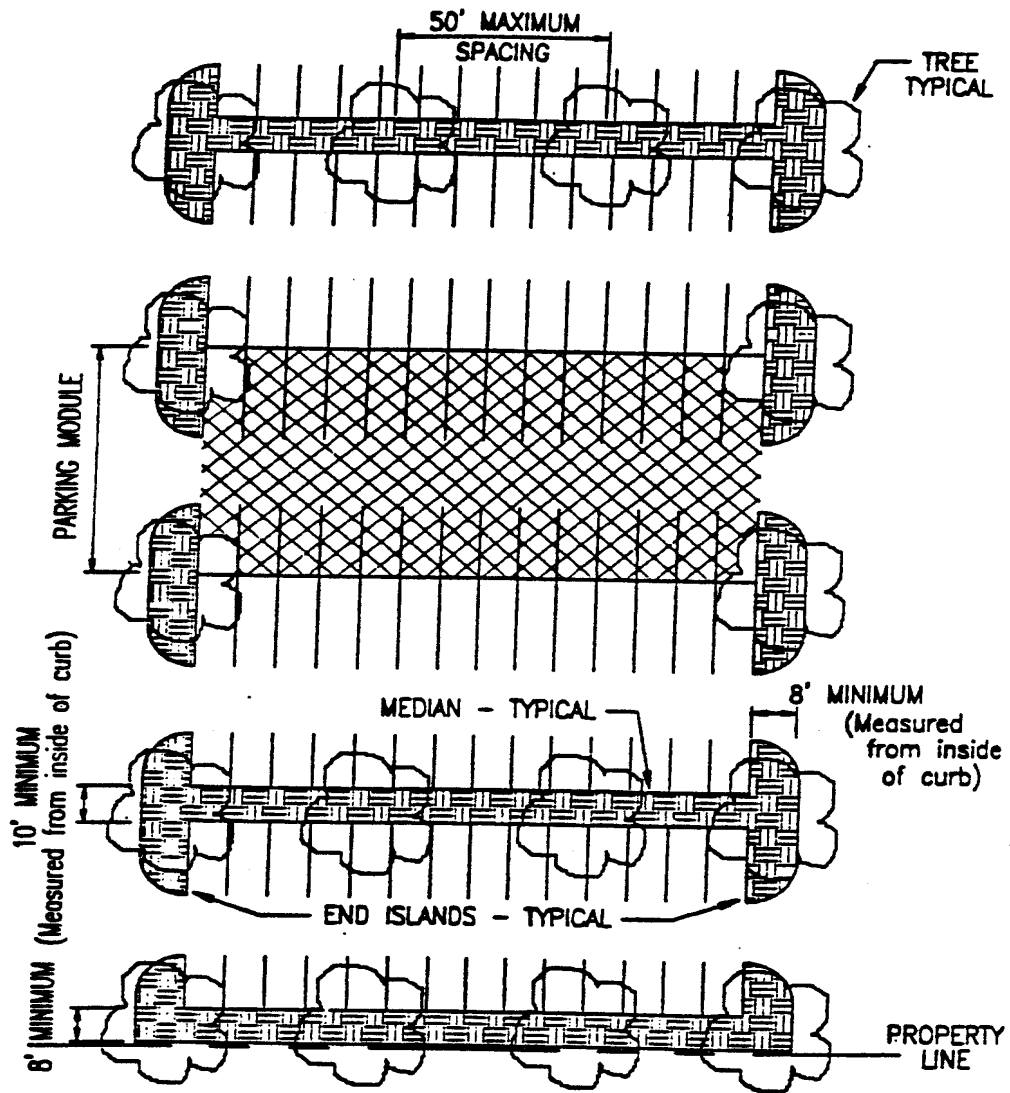

Layout for Large Parking Lots

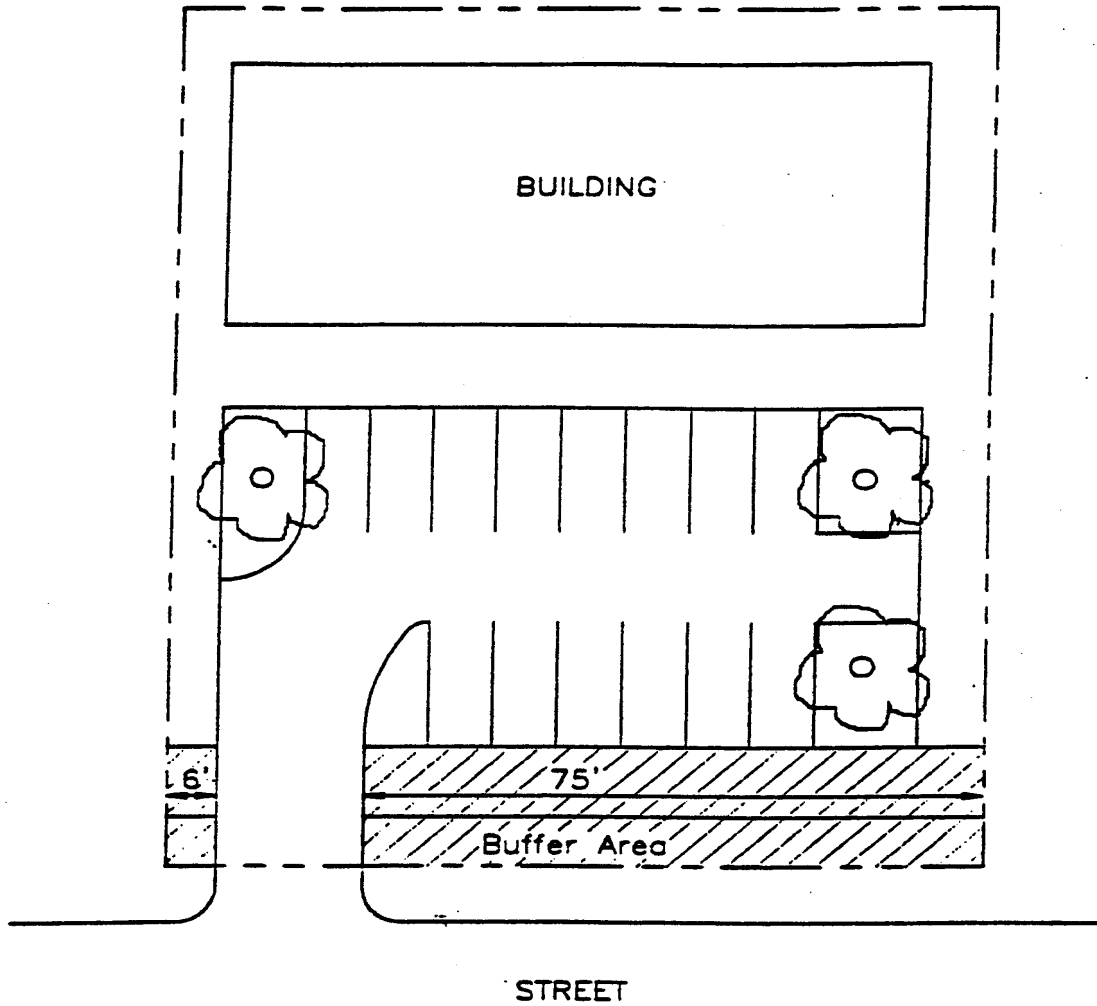

**BUFFER POINTS REQUIRED (as illustrated) = 81**

Example of Buffer Area Measurement

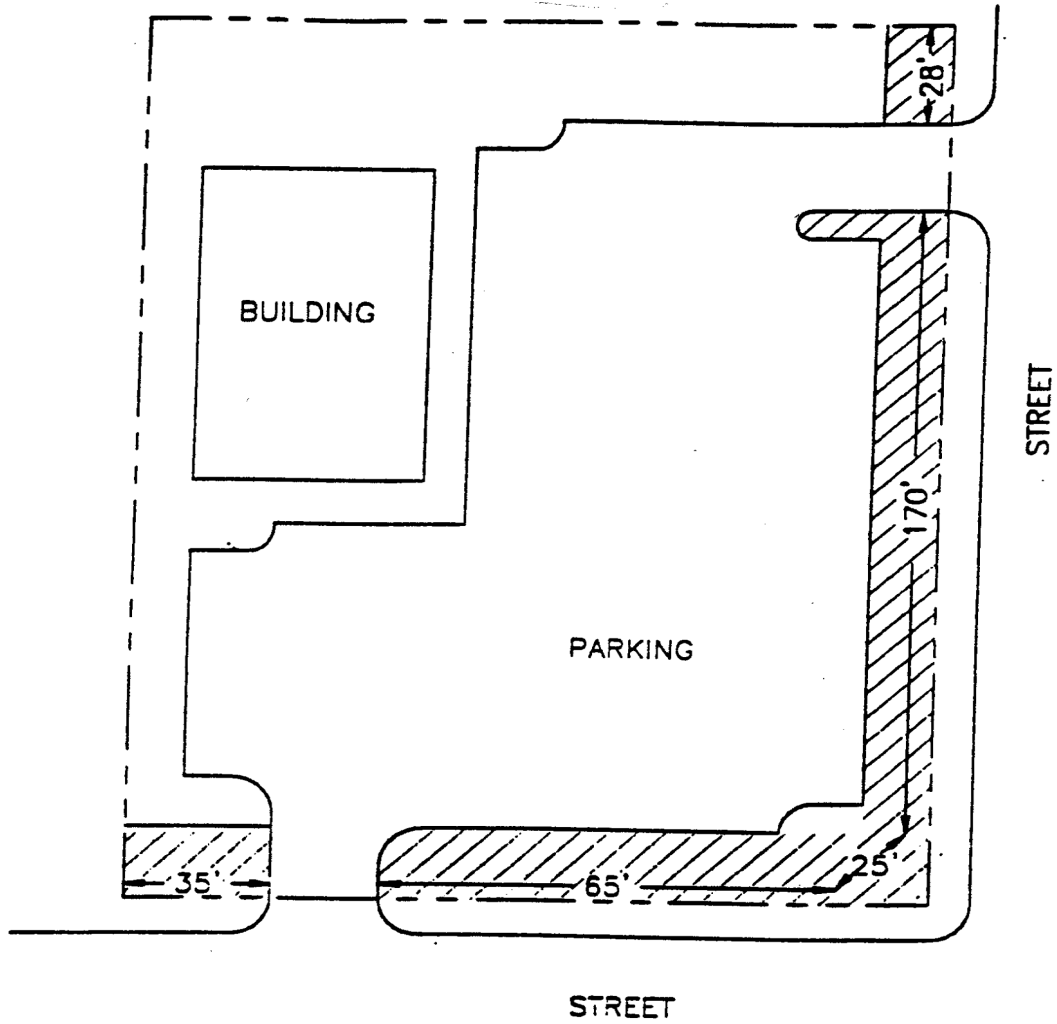

**BUFFER POINTS REQUIRED (as illustrated) = 323 Ft.**

Example of Buffer Area Measurement (Continued)

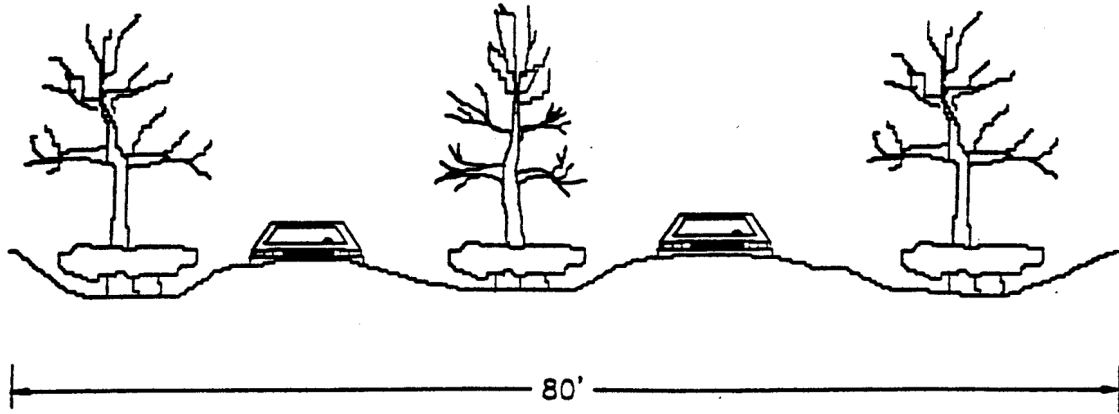

BUFFER PLANTING		
POINTS REQUIRED	ELEMENTS	POINTS ILLUSTRATED
80' X 1 pt./ft. = 80 pts.	0 Shrubs	0 Shrubs = 36 pts.
	0 Trees	0 Trees = 27 pts.
	0 Berms	0 Berms = 25 pts.
		<u>88 pts.</u>

Example of Buffer Planting

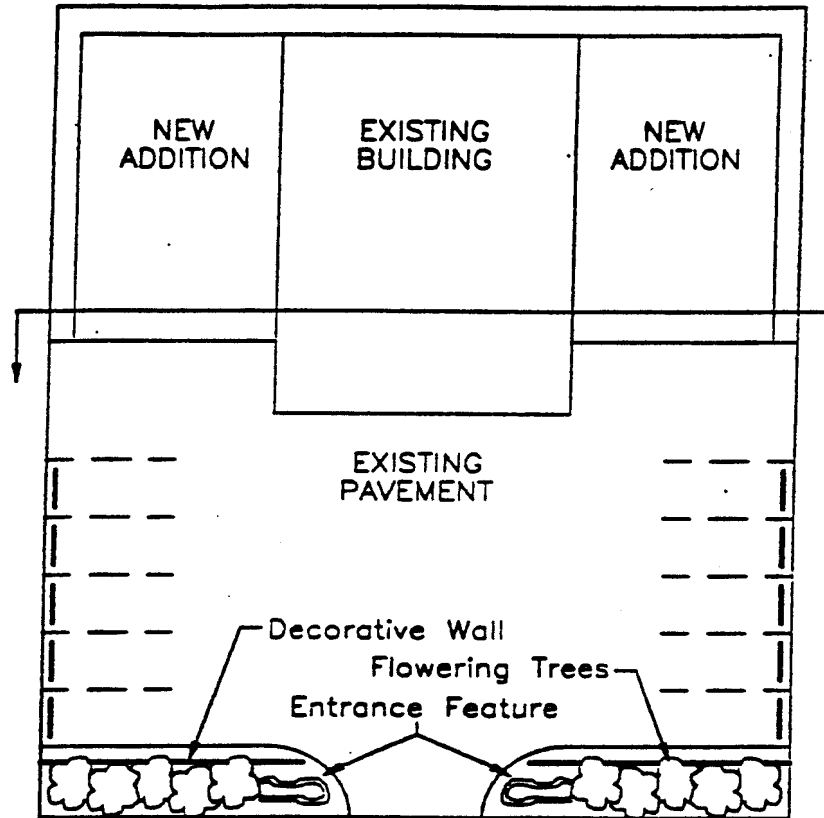

- ALTERNATIVE COMPENSATION**
- o Buffer Increase
  - o Native Trees & Shrubs
  - o Entrance Color Planting

Alternative Compliance — Example Solution

Figure 2-7  
Alternative Compliance  
Landscape Calculation List

This calculation list should be substituted for the General Landscape Calculation List on all landscape plans that are part of an Alternative Compliance Proposal.

		Required	Provided
1.	Total Site Area (Sq. Ft.)		
2.	Street Yard Area (Sq. Ft.)		
3.	Lanscaped Street Yard Area (Sq. Ft.)		
4.	Street Yard Trees (No.)		
5.	Street Yard Parking Islands/Peninsula (Sq. Ft.)		
6.	Non-Street Yard Parking Islands/Peninsula (Sq. Ft.)	N/A	N/A
7.	Buffer Points		
8.	Code Sections for which Alternative Compliance is Requested:		
	A.		
	B.		
	C.		
9.	Alternative Compliance Points		

N/A = Not applicable

(Ord. 97040, passed 11-24-97; Ord. 2005-13, passed 4-11-05)



Fence Application

Phone: (361) 595-8019 / email: [tcavazos@cityofkingsville.com](mailto:tcavazos@cityofkingsville.com)

<b>Property information:</b>			
Project Address:		Legal Description:	
Zoning District:		Historic District: <input type="checkbox"/> Yes <input type="checkbox"/> No	
<b>Information:</b>			
Owner:		Contractor:	
Mailing Address:		Address:	
Phone:		Phone:	
E-mail:		E-mail:	
<b>Description of Work:</b>			
Land Use (check box)	<input checked="" type="checkbox"/> Residential	<input checked="" type="checkbox"/> Commercial	
Types of Material: (check box)			
<input checked="" type="checkbox"/> Chain Link	<input checked="" type="checkbox"/> Vinyl	<input checked="" type="checkbox"/> Stone	
<input checked="" type="checkbox"/> Solid Wood	<input checked="" type="checkbox"/> Wrought Iron	<input checked="" type="checkbox"/> Concrete Block	
<input checked="" type="checkbox"/> Brick	<input checked="" type="checkbox"/> Other		
Job Valuation: \$			
Total Job Valuation: \$			
<b>Required Documentation:</b>			
<input type="checkbox"/> Site Plan with fence location and height indicated (See page 2)			
<input type="checkbox"/> Show Property Lines and Setbacks (See accepted drawings on page 3)			
<input type="checkbox"/> Image or drawing depicting fence design			
Signature (Applicant):		Date:	
<b>City of Kingsville Only</b>			
Permit Fee: \$50		Date Paid: _____	
Permit #			
Remarks:			
_____			
_____			
Approved by: _____		Date: _____	



# Fence Site Plan

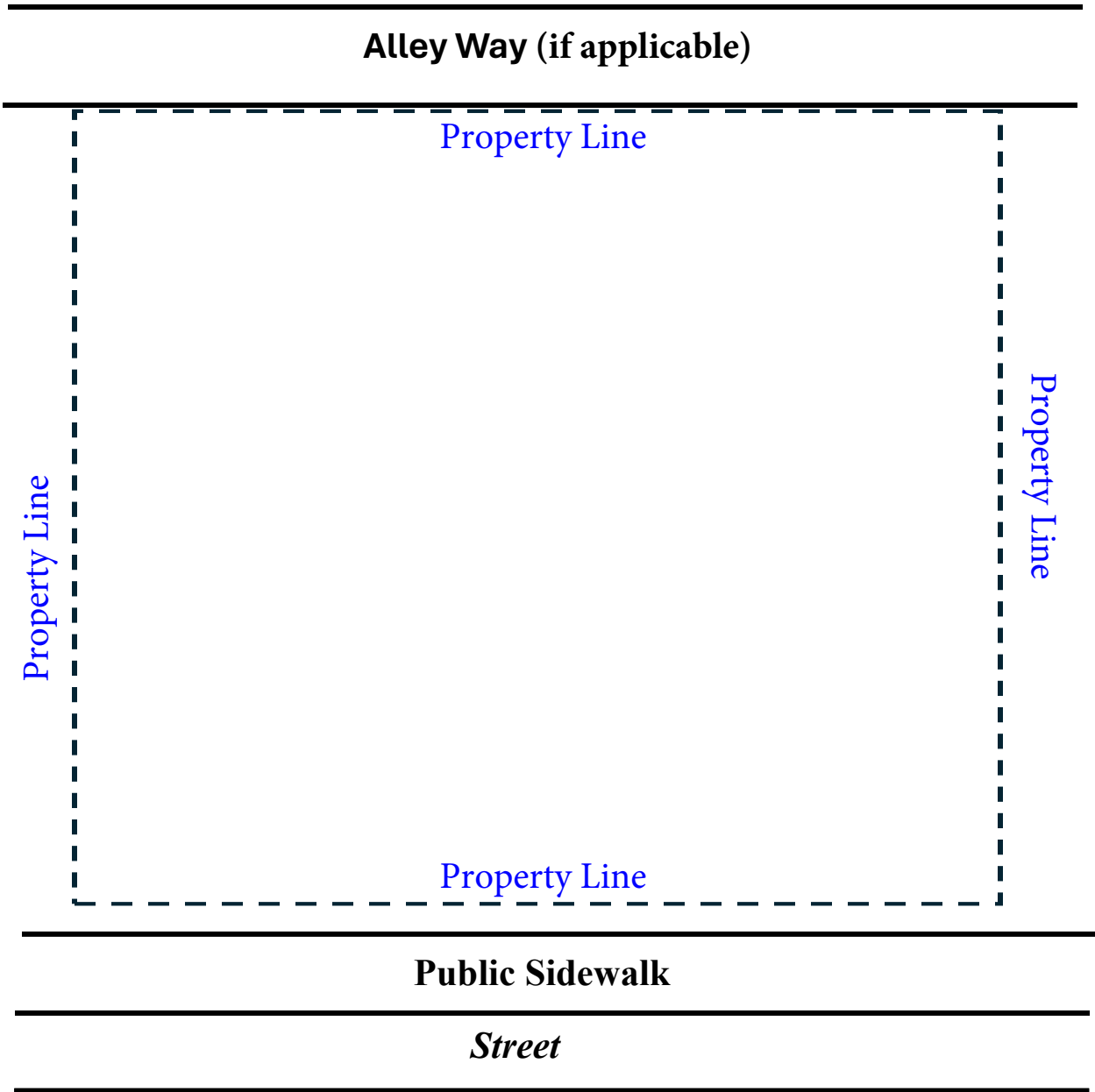

Picture of Fence

# Sample of Accepted Fence Site Plan & Picture

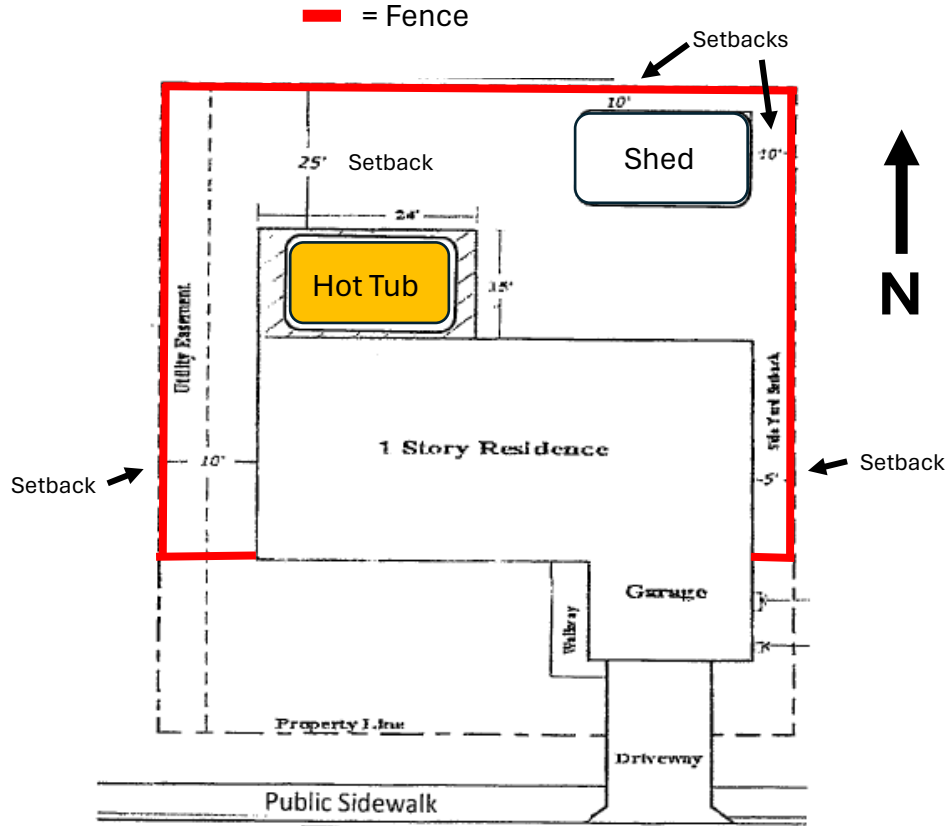

## City of Kingsville Fence Ordinances

[https://library.municode.com/tx/kingsville/codes/code\\_of\\_ordinances?nodeId=PT2COOR\\_CHXVLAUS\\_ART6ZO\\_USREDI\\_S15-6-28FERE](https://library.municode.com/tx/kingsville/codes/code_of_ordinances?nodeId=PT2COOR_CHXVLAUS_ART6ZO_USREDI_S15-6-28FERE)

- Fence Regulations (Sec. 15-6-28)
- Barbed Wire and Electric Fences (Sec. 13-1-2)
- Fence Maintenance (Sec. 15-1-17)
- Space Requirements Appendix B, Space Requirements for Non-Residential Use Sec. 1 & 2 (Article 6, Appendix B)



# City of Kingsville

Permit Instructions & Application for Signs & Billboards  
 email: [tcavazos@cityofkingsville.com](mailto:tcavazos@cityofkingsville.com) / Phone (361) 595-8019

Project Address:		Owner:
Applicant:		
Address:		Phone:
<b>Type of Proposed Sign:</b>		
On Premise	Fascia	Cantilevered
Off Premise (billboard)	Monument	Temporary
Roof Top	Awning	Illuminate; <b>IF YES,</b>
Wall	Pole	Is there an existing circuit?
<b>INSTRUCTIONS:</b>		
<p><b>Caution:</b> Lot lines <b>do not</b> normally coincide with curbs, graded ditches or sidewalks, and many signs are not located on lot lines. If you are not sure of the exact location of lot lines, have a land surveyor locate them.</p>		
<b>ATTACH THE FOLLOWING WITH THE APPLICATION:</b>		
<ol style="list-style-type: none"> <li>1. Legal description of the property (use page 2 of this application)</li> <li>2. Scaled drawing of site and picture of sign (if sign is detached from building) (use page 2 of this application)</li> <li>3. Scaled drawings of construction and installation (drawings <b>must be stamped by a registered professional engineer if</b> the proposed sign(s) will hang over public right of way, be closer to the public right-of-way than the height of the sign, or have a height of more than 15 feet)</li> <li>4. If installed over public right-of-way, written permission from the City's Public Works Director <b>is required</b></li> <li>5. Engineered plans required for all signage depicting <b>it meets 140mph wind load</b>, foundation details and/or sign fasteners and facing</li> </ol>		
Describe any easements on the proposed site:		
Signed (applicant):		Date:
<b>*****This section to be completed by Planning Department*****</b>		
Zoning District:	Street Width:	Street type:
Historic District:	Value of Project: \$	
<b>Billboards:</b>	<b>Ordinances of Interest:</b> Sec 15-1-63; 15-6-119; 15-6-118; 15-1-100;	
Total Sign Area:	15-6-130; 15-6-124	
<b>Permit Fees:</b>		
<input type="checkbox"/> \$25 Review Fee + \$0.20 per sq ft		\$ _____
<b>(For illuminated temporary signs, permanent wiring must be within 6')</b>		
<input type="checkbox"/> Electrical Permit Required		<b>Remarks:</b>
Approved by: _____		Date: _____

# Sign/Billboard Site Plan

---

Legal Description of property:

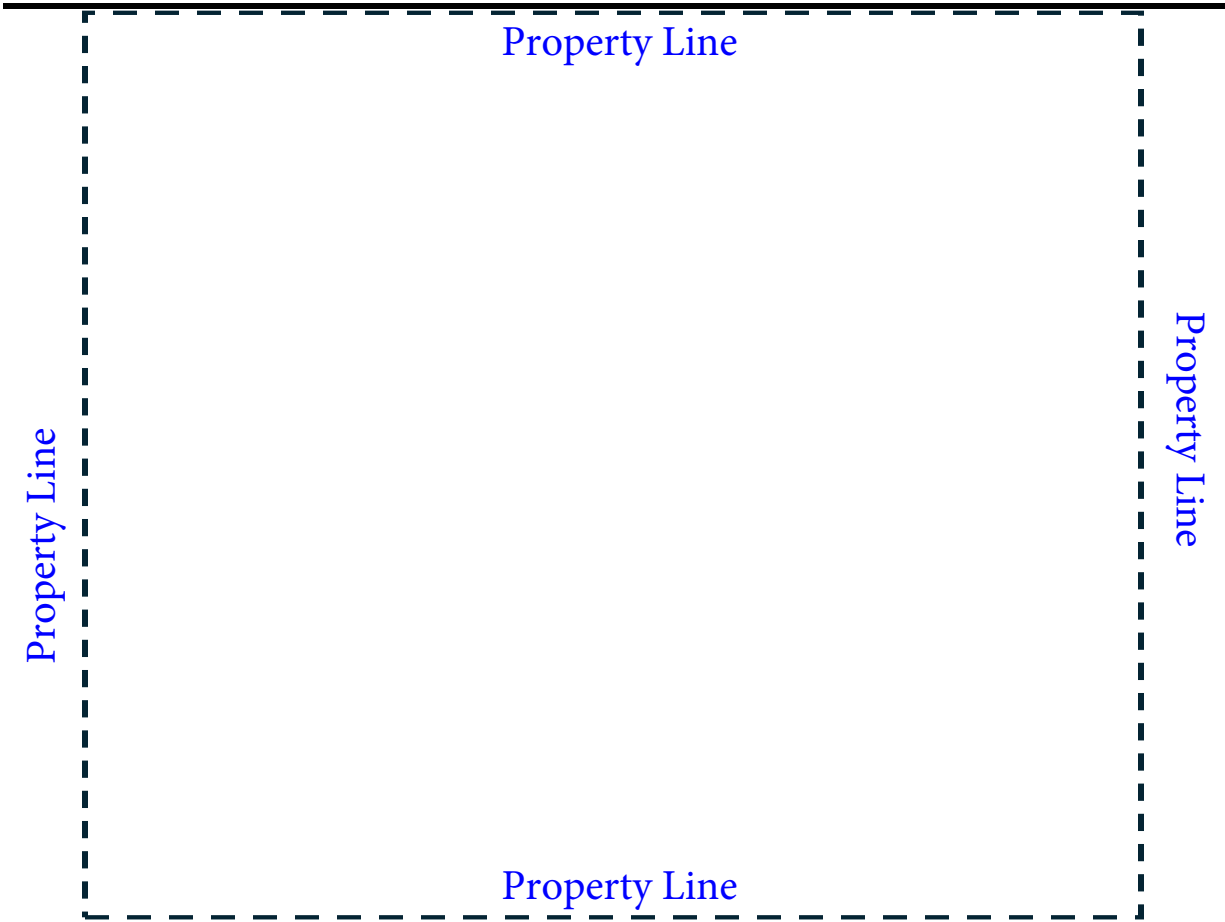

---

**Public Sidewalk (if applicable)**

---

*Street*

---



**Picture of Sign or Billboard**

## First question...do I need an inspection?

Short answer: Probably...please see the list of projects below that require an inspection:

**Types of inspections.** Due to the varying nature of construction, the types of inspections vary. The most common inspections are listed below and **should not** be construed as the only required inspections. If there are any questions, please feel free to reach out to the City of Kingsville development services.

### **Building**

1. Footing (piers)
2. Foundation (pre pour)
3. Framing (including exterior sheathing before it is covered by a weather barrier.)
4. Masonry
5. Insulation
6. Fire Rated Assembly (including, but not limited, to drywall at required separations)
7. Building Final
8. Sidewalk/Driveway (city sidewalk and approach in easement)
9. Certificate of Occupancy

### **Mechanical**

1. Mechanical Rough
2. Mechanical Final
3. Energy Final (duct tightness, where applicable, and blower door tests)

### **Electrical**

1. Temp power
2. Underground
3. Electrical Rough
4. Meter loop (permanent power)
5. Electrical Final

### **Fire**

1. Fire Life Safety Overall Annual

### **Plumbing**

1. Underground Plumbing
2. Sewer Connection
3. Waterline
4. CSI - Water line
5. Plumbing top out
6. Plumbing Final

### **Fuel Gas**

1. Underground
2. Rough in

3. Final

**NOTE:** Work shall not be performed beyond the point indicated in each successive inspection without first obtaining the approval of the building official. The building official, upon notification, shall make the requested inspections and shall either indicate the portion of the construction that is “satisfactory as completed,” or shall notify the permit holder or an agent of the permit holder wherein the same “fails to comply.” Any portions that do not comply shall be corrected and such portion shall not be covered or concealed until authorized by the building official.

To schedule an inspection, call the City of Kingsville Planning & Development Services Department at  
(361) 595-8019/8055



Fee of \$75.00 due upon submission. An additional fee per floor charged for multi-story buildings

### Certificate of Occupancy Application

<b>Project Information</b>	
Proposed Business Name: _____	Proposed Business Use: _____
Project Address: _____	
Total Parking Spaces: _____	Legal Description: _____
Total Occupancy of Building: _____	Sq. Ft.: _____ Zoning District: _____

<b>Owner Information</b>	
Company Name: _____	Contact Person: _____
Street Address: _____	
Email: _____	
Phone: _____	Fax: _____ Mobile: _____

<b>Tenant Information</b>	
Company Name: _____	Contact Person: _____
Street Address: _____	
Email: _____	
Phone: _____	Fax: _____ Mobile: _____

**Does your business involve the storage, sale or use of the following? (Check all that apply)**

- Painting with flammables
- Combustible Fibers
- Cellulose Nitrate Film
- Compressed Gas
- Liquid Propane Gas
- Vehicle Repair Garage
- Welding or Cutting
- Dry Cleaning Solvents
- Dust producing process
- Explosives/Ammunition
- Recycling Waste
- Magnesium
- Vehicles in Building
- Woodworking
- Flammable/combustible liquids (10 gallons or more)
- Floor drains in building
- Food and/or beverage processing, storage or sales
- Food products
- High piled stock (over 12' in height)
- Poisonous or hazardous chemicals/acids
- X-ray Development
- Alcohol
- Smoking
- Fireworks

**\*\*Provide chemical data sheets to the Building Inspection Department listing the maximum quantity of all hazardous materials.\*\* List any material discharged into the drainage system, ground, or atmosphere: \_\_\_\_\_**

It shall be unlawful to use or occupy or permit the use or occupancy of any building or premises created, erected, changed, converted or altered or enlarged in its use or structure until a Certificate of Occupancy shall have been issued by the administrative official. A permit becomes null and void if work or construction authorized is not commenced within 180 days, or if construction or work is suspended or abandoned for a period of 180 days at any time after work is commenced.

I hereby certify that I have read and examined this application and know the same to be true and correct. All provisions of laws and ordinances governing this type of work will be complied with whether specified or not. The granting of a permit does not presume to give authority to violate or cancel the provisions of any other state or local law regulating construction or the performance of construction.

**Signature of Applicant:** \_\_\_\_\_ **Date:** \_\_\_\_\_

Building Official	Approved By	Date	Comments
Fire Department			
Health Department (as req'd)			
Application Approved: _____		Date Issued: _____	
Certificate of Occupancy Verified by Planning Director: _____		Date Signed: _____	

**City of Kingsville Ordinances of Interest:****Building Code:**

[https://library.municode.com/tx/kingsville/codes/code\\_of\\_ordinances?nodeId=PT2COOR\\_CHXVLAUS\\_ART1BURE\\_BUCO](https://library.municode.com/tx/kingsville/codes/code_of_ordinances?nodeId=PT2COOR_CHXVLAUS_ART1BURE_BUCO)

**Plumbing Code:**

[https://library.municode.com/tx/kingsville/codes/code\\_of\\_ordinances?nodeId=PT2COOR\\_CHXVLAUS\\_ART1BURE\\_PLCO](https://library.municode.com/tx/kingsville/codes/code_of_ordinances?nodeId=PT2COOR_CHXVLAUS_ART1BURE_PLCO)

**Fuel Gas Code:**

[https://library.municode.com/tx/kingsville/codes/code\\_of\\_ordinances?nodeId=PT2COOR\\_CHXVLAUS\\_ART1BURE\\_FUGACO](https://library.municode.com/tx/kingsville/codes/code_of_ordinances?nodeId=PT2COOR_CHXVLAUS_ART1BURE_FUGACO)

**Electrical Code:**

[https://library.municode.com/tx/kingsville/codes/code\\_of\\_ordinances?nodeId=PT2COOR\\_CHXVLAUS\\_ART1BURE\\_ELCO](https://library.municode.com/tx/kingsville/codes/code_of_ordinances?nodeId=PT2COOR_CHXVLAUS_ART1BURE_ELCO)

**Mechanical Code:**

[https://library.municode.com/tx/kingsville/codes/code\\_of\\_ordinances?nodeId=PT2COOR\\_CHXVLAUS\\_ART1BURE\\_MECO](https://library.municode.com/tx/kingsville/codes/code_of_ordinances?nodeId=PT2COOR_CHXVLAUS_ART1BURE_MECO)

**Swimming Pool Code:**

[https://library.municode.com/tx/kingsville/codes/code\\_of\\_ordinances?nodeId=PT2COOR\\_CHXVLAUS\\_ART1BURE\\_SWPOCO](https://library.municode.com/tx/kingsville/codes/code_of_ordinances?nodeId=PT2COOR_CHXVLAUS_ART1BURE_SWPOCO)

**Residential Code for 1 and 2-Family Dwellings:**

[https://library.municode.com/tx/kingsville/codes/code\\_of\\_ordinances?nodeId=PT2COOR\\_CHXVLAUS\\_ART1BURE\\_RECOOMIDW](https://library.municode.com/tx/kingsville/codes/code_of_ordinances?nodeId=PT2COOR_CHXVLAUS_ART1BURE_RECOOMIDW)

**Permit and License Provisions:**

[https://library.municode.com/tx/kingsville/codes/code\\_of\\_ordinances?nodeId=PT2COOR\\_CHXVLAUS\\_ART2MOHOMOHOPA\\_PELIPR](https://library.municode.com/tx/kingsville/codes/code_of_ordinances?nodeId=PT2COOR_CHXVLAUS_ART2MOHOMOHOPA_PELIPR)

**Energy Conservation Code:**

[https://library.municode.com/tx/kingsville/codes/code\\_of\\_ordinances?nodeId=PT2COOR\\_CHXVLAUS\\_ART1BURE\\_ENCOCO](https://library.municode.com/tx/kingsville/codes/code_of_ordinances?nodeId=PT2COOR_CHXVLAUS_ART1BURE_ENCOCO)

**Existing Building Code:**

[https://library.municode.com/tx/kingsville/codes/code\\_of\\_ordinances?nodeId=PT2COOR\\_CHXVLAUS\\_ART1BURE\\_EXBUCO](https://library.municode.com/tx/kingsville/codes/code_of_ordinances?nodeId=PT2COOR_CHXVLAUS_ART1BURE_EXBUCO)

**Subdivisions:**

[https://library.municode.com/tx/kingsville/codes/code\\_of\\_ordinances?nodeId=PT2COOR\\_CHXVLAUS\\_ART3SU](https://library.municode.com/tx/kingsville/codes/code_of_ordinances?nodeId=PT2COOR_CHXVLAUS_ART3SU)

**Platting Procedures:**

[https://library.municode.com/tx/kingsville/codes/code\\_of\\_ordinances?nodeId=PT2COOR\\_CHXVLAUS\\_ART3SU\\_PLPR](https://library.municode.com/tx/kingsville/codes/code_of_ordinances?nodeId=PT2COOR_CHXVLAUS_ART3SU_PLPR)

**Design Standards:**

[https://library.municode.com/tx/kingsville/codes/code\\_of\\_ordinances?nodeId=PT2COOR\\_CHXVLAUS\\_ART3SU\\_DEST](https://library.municode.com/tx/kingsville/codes/code_of_ordinances?nodeId=PT2COOR_CHXVLAUS_ART3SU_DEST)



**Drainage:**

[https://library.municode.com/tx/kingsville/codes/code\\_of\\_ordinances?nodeId=PT2COOR\\_CHXVLAUS\\_ART3SU\\_DR](https://library.municode.com/tx/kingsville/codes/code_of_ordinances?nodeId=PT2COOR_CHXVLAUS_ART3SU_DR)

**Zoning:**

[https://library.municode.com/tx/kingsville/codes/code\\_of\\_ordinances?nodeId=PT2COOR\\_CHXVLAUS\\_ART6ZO](https://library.municode.com/tx/kingsville/codes/code_of_ordinances?nodeId=PT2COOR_CHXVLAUS_ART6ZO)

**Sign Regulations:**

[https://library.municode.com/tx/kingsville/codes/code\\_of\\_ordinances?nodeId=PT2COOR\\_CHXVLAUS\\_ART6ZO\\_SIRE](https://library.municode.com/tx/kingsville/codes/code_of_ordinances?nodeId=PT2COOR_CHXVLAUS_ART6ZO_SIRE)

**Appendix A – Land Use Categories:**

[https://library.municode.com/tx/kingsville/codes/code\\_of\\_ordinances?nodeId=PT2COOR\\_CHXVLAUS\\_ART6ZO\\_APXALAUSSCA](https://library.municode.com/tx/kingsville/codes/code_of_ordinances?nodeId=PT2COOR_CHXVLAUS_ART6ZO_APXALAUSSCA)

**Appendix B- Space Requirements:**

[https://library.municode.com/tx/kingsville/codes/code\\_of\\_ordinances?nodeId=PT2COOR\\_CHXVLAUS\\_ART6ZO\\_APXBSPRE](https://library.municode.com/tx/kingsville/codes/code_of_ordinances?nodeId=PT2COOR_CHXVLAUS_ART6ZO_APXBSPRE)

# Points of Contact

<u>Position</u>	<u>Name</u>	<u>Email address</u>	<u>Phone #</u>
Permit Clerk	Mrs. Theresa Cavazos	<a href="mailto:tcavazos@cityofkingsville.com">tcavazos@cityofkingsville.com</a>	361-595-8019
Senior Planner	Mr. Kobby Agyekum	<a href="mailto:kagyekum@cityofkingsville.com">kagyekum@cityofkingsville.com</a>	361-221-6754
Building Official	Mrs. Belinda Tarver	<a href="mailto:btarver@cityofkingsville.com">btarver@cityofkingsville.com</a>	361-595-8020
Building Inspector	Vacant	TBD	361-595-8022
City Engineer	Mr. Rutilio Mora	<a href="mailto:rmora@cityofkingsville.com">rmora@cityofkingsville.com</a>	361-595-8004
Health Director	Mr. Emilio Garcia Mr.	<a href="mailto:egarcia@cityofkingsville.com">egarcia@cityofkingsville.com</a>	361-592-3324
Public Works Director	Bill Donnel	<a href="mailto:wdonnell@cityofkingsville.com">wdonnell@cityofkingsville.com</a>	361-595-8051
Fire Marshal	Mr. Steve Palacios	<a href="mailto:fmo@cityofkingsville.com">fmo@cityofkingsville.com</a>	361-221-6757
Downtown Manager	Mrs. Alicia Tijerina	<a href="mailto:atijerina@cityofkingsville.com">atijerina@cityofkingsville.com</a>	361-592-8516
Chamber of Commerce	Mr. Manny Salazar	<a href="mailto:manny@kingsville.org">manny@kingsville.org</a>	361-592-6438