



City of Kingsville

Residential Construction Pre-Development Application & Statement of Acknowledgement

Email to: hsolis@cityofkingsville.com; Ph: (361) 595-8055

GENERAL INFORMATION

Property Owner Name: _____ Ph #: _____

Project Name: _____ Email: _____

Project Address: _____

Zoning Classification: _____ (see GIS app via: <https://kingsvillegis.com/#/mwl>)

Is property zoned for its intended use? Yes No (If no, rezoning is required; explain process: PNZ/Commission/etc. Fill out **Tab A and B**)

Is property platted? Yes No (If no, explain process: PNZ/Commission/etc. Fill out **Tab A**)

Is property in the Historic District? Yes No (If yes, Historical Development Board (HDB) approval is required prior to issuing a permit; explain process. Fill out HDB Review Application **Tab C**)

Is property in the Floodplain? Yes No (If yes, obtain elevation certificate prior to issuing permit. Fill out **Tab D (see Engineering)**)
(Use FEMA Flood Map Service Center website)

Contractor(s): _____ Are they licensed in the City of Kingsville? Yes No
_____ (If no, fill out **Tab E**)

Engineer Name: _____ Ph #: _____ Email: _____

Architect Name: _____ Ph #: _____ Email: _____

Schedule MANDATORY in-person meeting on Tuesdays at 2:30pm (Development Review Team):

Call (361) 595-8055 Date: _____

Plan Review Fee of \$250 collected on _____ Send to Bureau Veritas? Yes No

Tell us about your project

Demo? New Construction? Remodel? Addition?

Description of work to be completed:

Valuation of project: \$ _____ Project sq ft: _____

Work start date: _____ Estimated date of work completion: _____

Please consult our City of Kingsville Ordinances before starting your project: Please find the ordinances at: https://library.municode.com/tx/kingsville/codes/code_of_ordinances

***For frequently used ordinances, see Tab Q**

Construction Plans Submittal Requirements (all plans must comply with the following codes):

- (2018 Building Code)
- (2018 Existing Building Code)
- (2018 Property Maintenance Code)
- (2018 International Fire Code/NFPA 101)
- (2017 National Electrical Code)

2 hard copy sets of full-size (24"x 36"), 1 hard copy set of reduced-size* (11"x 17") [drawn to architectural or engineer scale] + 1 electronic set (on a thumb drive, sent via email, etc.) See pp 3-9 for details

- a. _____ Site plan, including grading, drainage and utility plan with details + as required
(must be completed by a Texas Licensed Engineer)
- b. _____ Building: floor framing & walls, ceiling framing & roofing framing + pre-manufactured truss details
- c. _____ Plumbing
- d. _____ Irrigation (if applicable)
- e. _____ Electrical
- f. _____ Mechanical
- g. _____ Gas
- h. _____ Driveway and Sidewalks
- i. _____ Energy Compliance
- j. _____ Foundation
- k. _____ Landscaping
- l. _____ Elevation - all sides
- m. _____ (Texas Accessibility Standards)TAS
- n. _____ Texas Department of Insurance (TDI) Requirements/Windstorm Certification
- o. _____ Fire Prevention
- p. _____ Asbestos Survey (as required)
- q. _____ Elevation Certificate
- r. _____ Additional Info (as required) _____

Points of Contact:

Permit Clerk	Mrs. Theresa Cavazos	tcavazos@cityofkingsville.com	361-595-8019
Senior Planner	Mr. Kobby Agyekum	kagyekum@cityofkingsville.com	361-221-6754
Building Official	Mrs. Belinda Tarver	btarver@cityofkingsville.com	361-595-8020
Building Inspector	TBD	TBD	361-595-8022
City Engineer	Mr. Rutilio Mora	rmora@cityofkingsville.com	361-595-8004
Public Works Director	Mr. Bill Donnell	wdonnell@cityofkingsville.com	361-595-8051
Fire Marshal	Mr. Steve Palacios	spalacios@cityofkingsville.com	361-592-6445

"I fully understand and acknowledge all requirements within this application"

Owner Signature: _____ Date: _____

Owner Printed Name: _____

Planning Director Signature: _____ Date: _____

Submittal Guidelines for Residential Permits

(Bureau Veritas)

New Single Family Residence

- Application
- Site Plan
- Building Plans
- Energy Compliance Report

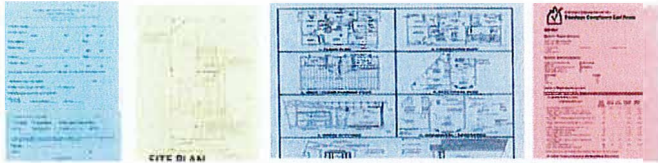

New Residential Detached Accessory Building

- Application
- Site Plan
- Building Plans

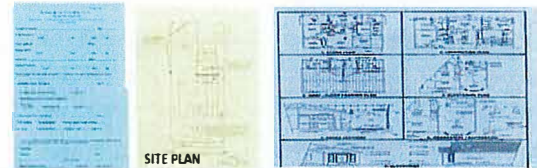

New Single Family Addition

- Application
- Site Plan
- Building Plans
- Energy Compliance Report
- Floor Plan Showing Existing and New Addition

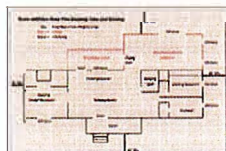
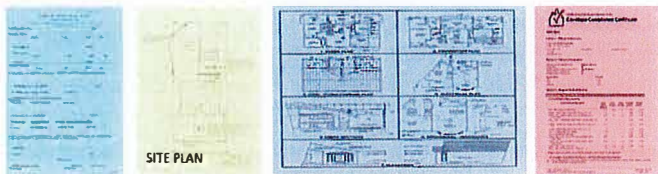

Pool and Spas

- Application
- Site Plan
- Pool Detail

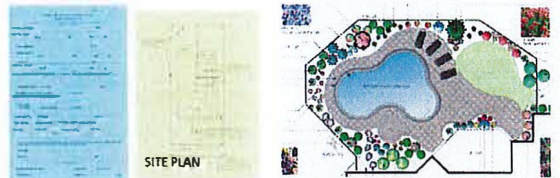

Trade Permits / Minor / No Review

- Application / Note: **Inspection Only**



Electrical Repair
 Plumbing Repair
 Mechanical Repair
 Electrical Service Upgrade
 Siding / Veneer
 Re-Roof
 Irrigation System
 Concrete Deck / Slabs
 Foundation Repair

Interior Residential Remodel

- Application
- Scope of Work Description Sheet
- Floor Plan / Before and After

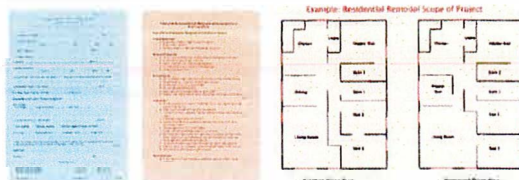

Site Plan should provide the following information

- North Arrow
- Address / Subdivision / Lot Number / Block Number
- Scale: i.e. 1" = 10' / 1" = 20' / 1" = 30' Please use either an Engineer or Architectural scale only. Nonstandard scales are not acceptable for example 1" = 26.5 or 1" = 16')
- Parcel / Property Dimensions all sides.
- Show setback dimensions to all structures from property line and distances between buildings .
- Label all structures i.e. Residence, Barn, Detached Garage, Storage Shed, etc.
- Dedicated driveway access to property showing street name and or alley where applicable.
- Driveway must be labeled Driveway or "DW"
- Show Easements (ingress / egress easements, public utility easements, etc.
- Square footage of all structures / existing and new

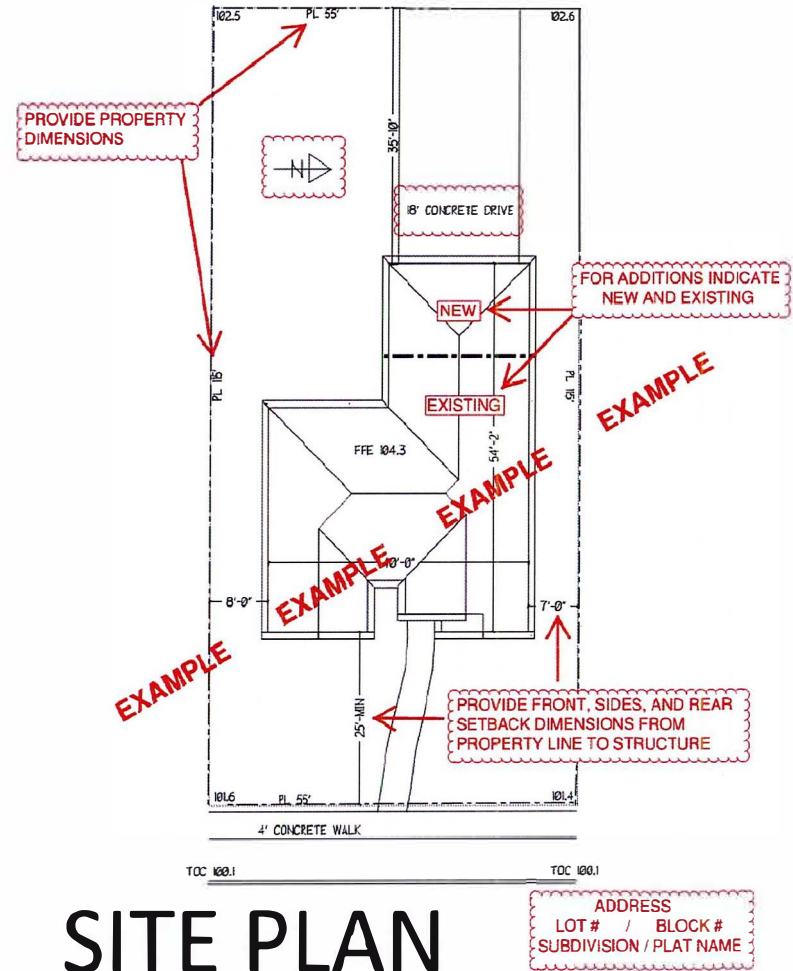

Construction plans should include the following details

1. Floor Plan

- Dimensions, room titles, and ceiling heights
- Location and labeling of all appliances
- Square footage summary (Livable, garage, patios, and total under roof)
- Door and window type and size (ex: single hung, French, etc.)
- All adjacent rooms to an addition in its entirety showing the door and window sizes

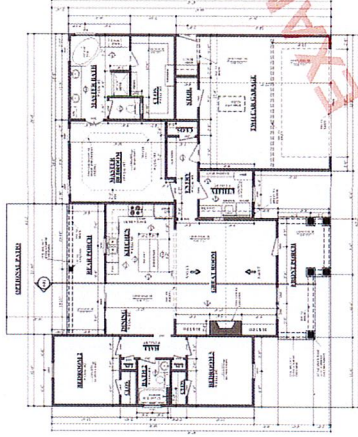

1. Floor Plan

2. Roof / Floor Framing Plan

- Size of all individual header and beam sizes
- Label all structural members such as rafters, joist, trusses, over framing, and their spacing

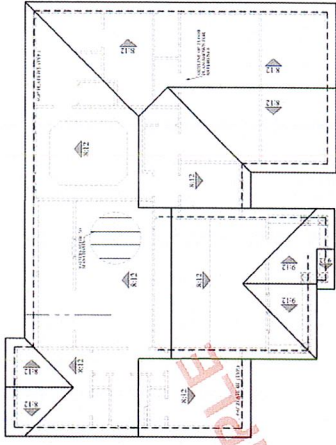

2. Roof / Floor Framing Plan

3. Cross Sections

- All connection details keyed in
- Basic outline of all structural members Including beams, trusses, hardware, blocking, footings, post, concrete slab, Insulation, over framing, etc.

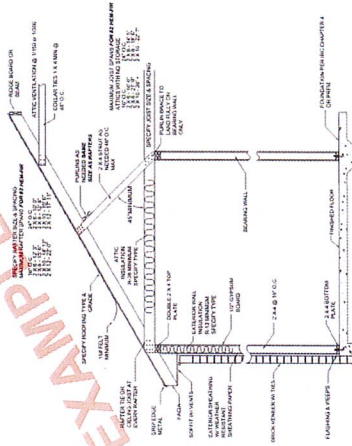

3. Cross Section Plan

4. Foundation Plan

- Post sizes at all columns supporting concentrated loads
- Footing size dimensions, and depth

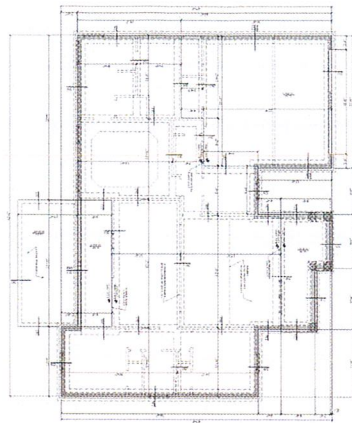

4. Foundation Plan

5. Electrical Plan

- Receptacle and lighting placement
- Labeling of special hardware required such as disconnects, weatherproof receptacles, GFCI outlets, meter and sub-panel locations, etc
- Location of smoke and carbon detectors
- Location of all appliances such as air conditioners and air handlers

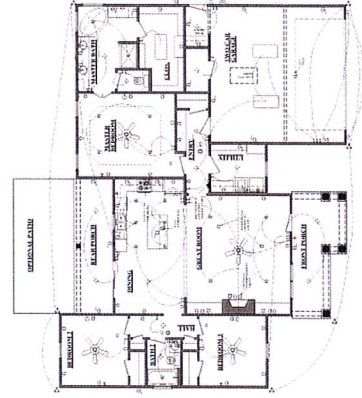

5. Electrical Plan

6. Elevations

- Masonry Percentage calculations
- Height location for grade, finish floor, header heights, top plate heights, ridges, etc.
- Slope of roof and floor elevation heights need to be represented correctly. Exterior finishes for roofs and walls

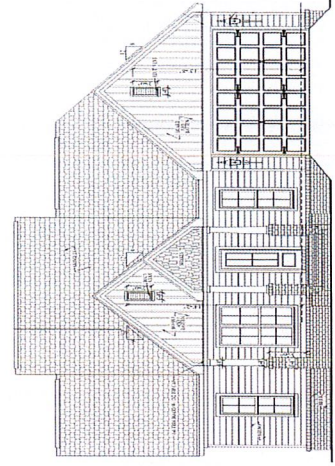

6. Elevation

7. Other Documents

- Energy Report
- Engineering
- Other Documents

Stair and Guardrail Details (If applicable)

Energy Compliance Report

An Energy Compliance report is a document that verifies the structures meets and or exceeds the minimum requirements of the International Energy Conservation Code or IECC. The report will include the address / Location of the structure along with other information specific to the structure. It will state that the structure meets, exceeds or PASSES the energy efficiency requirements. The following three types are most common in calculating and generating an energy report and are acceptable. In addition an Energy Specialist Company may also provide a report.

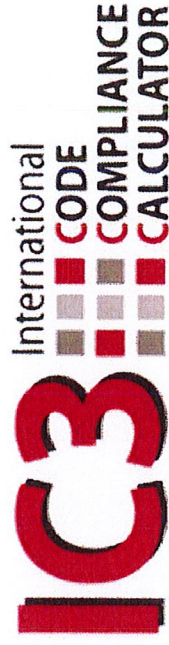
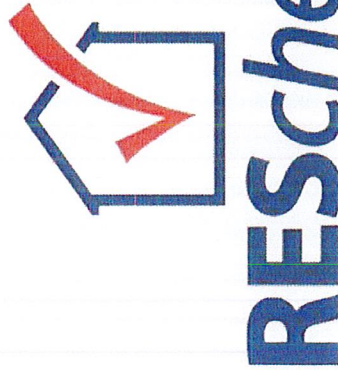

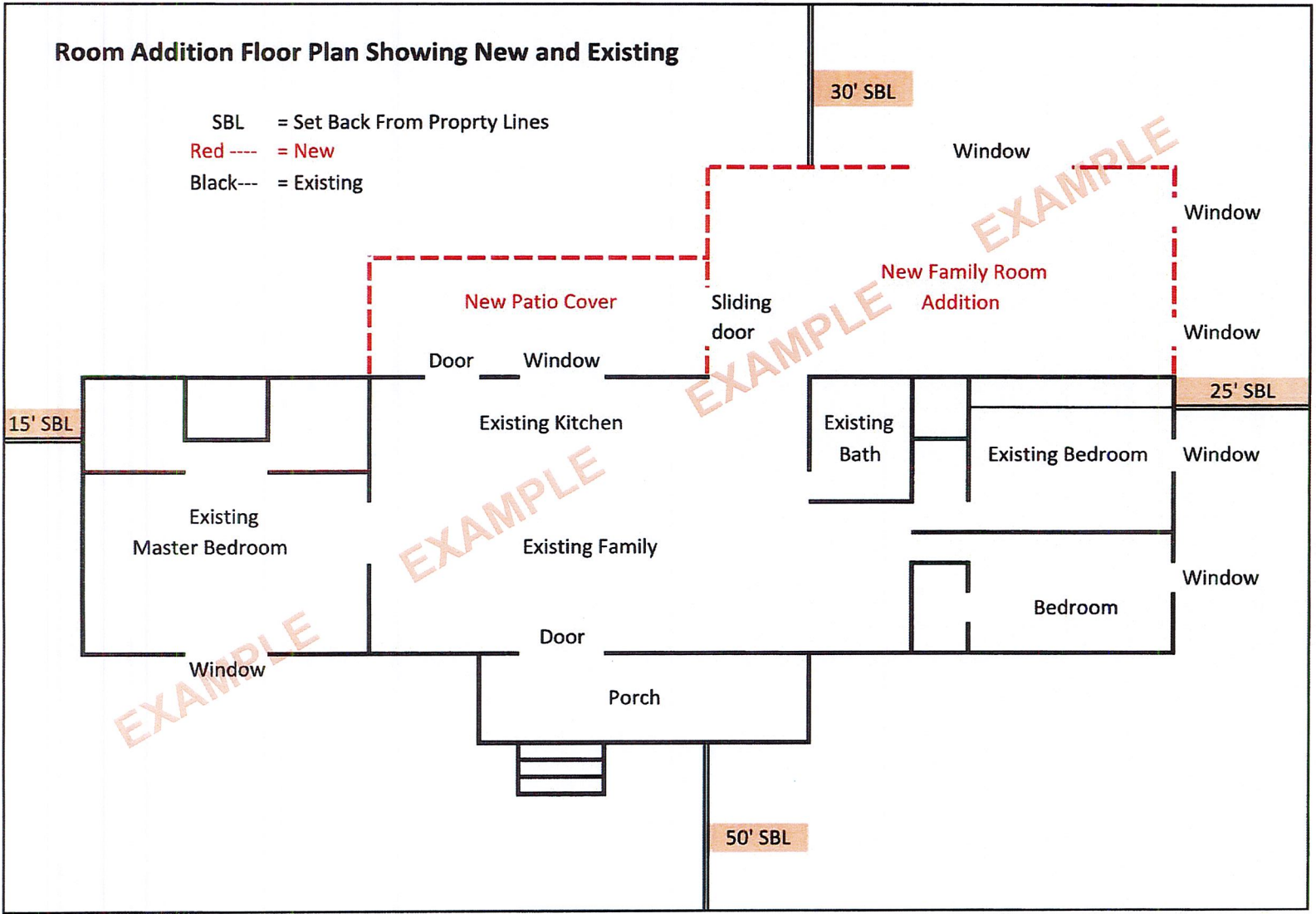

Remodel / Scope of Project

For

The Smith Residence Remodel / 1234 Central Avenue, Anywhere USA 12345

Living Room:

- Shorten hallway and increase living room area by removing section of non-bearing wall that separates the hall from the living room (see floor plan)
- Replace all electrical receptacles and switches with new
- Install ceiling fan
- Replace all trim / molding
- Paint
- Remove and replace carpet

Dining Room:

- Convert Dining room into Private Den by adding a wall and passage door
- Replace all electrical receptacles and switches with new
- Install ceiling fan
- Replace all trim / molding
- Paint
- Remove and replace carpet

Kitchen and Laundry area

- Install new cabinets and counter tops
- Install new plumbing fixtures
- Install new appliances
- Replace all electrical receptacles and switches with new (GFCI)
- Install ceiling fan over sitting area
- Replace all trim / molding
- Paint
- Install tile flooring

Page 1 of 2 for interior remodel

Master Bedroom / Bedroom 2 / Bedroom 3

- Replace all electrical receptacles and switches with new
- Install ceiling fan
- Replace all trim / molding
- Paint
- Remove and replace carpet

Bath 1 and 2

- Replace all electrical receptacles and switches with new (GFCI)
- Install exhaust fan
- Replace all trim / molding
- Paint
- Install tile flooring

If removing a bearing wall:

- Indicate / Highlight location of wall
- Provide detail of beam size and support system including spread footing size.

Example: Residential Remodel Scope of Project

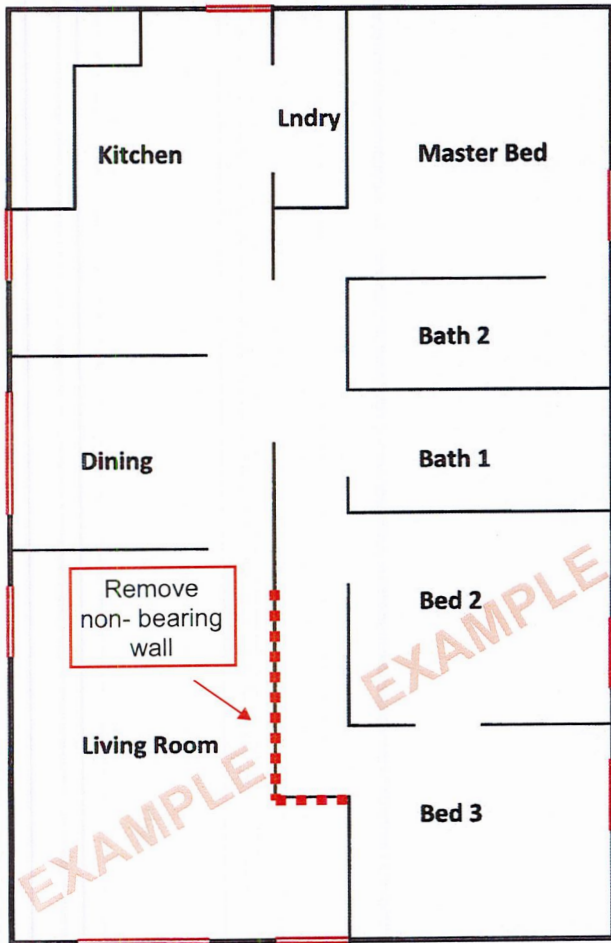

Existing Floor Plan

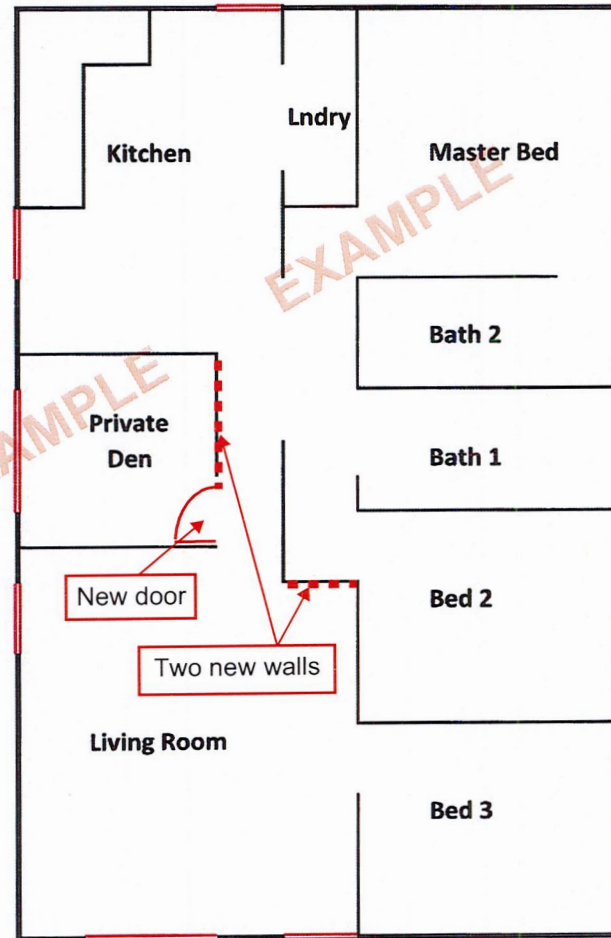

Proposed Floor Plan

Page 2 of 2 for interior remodel

Residential Building Application

Table of Contents

Tab A.....	Master Land Use Application
Tab B.....	Application Checklist for Re-Zoning
Tab C.....	Historical Development Board Review Application
Tab D.....	Floodplain Development Permit and Application Form
Tab E.....	Contractor License Application
Tab F.....	Application Checklist for Special Use Permits
Tab G.....	General Permit Information
Tab H.....	Building Permit Application
Tab I.....	Building Permit Conditions
Tab J.....	Permit Instructions and Application for Driveways/Sidewalk/Parking Lot
Tab K.....	Concrete Driveway & Sidewalk Details
Tab L.....	Permit Instructions and Application for Fences
Tab M.....	Landscaping Policy
Tab N.....	Inspection Information
Tab O.....	Certificate of Occupancy Application
Tab P.....	Ordinances of Interest
Tab Q.....	Points of Contact



**CITY OF KINGSVILLE
PLANNING AND ZONING DIVISION
MASTER LAND USE APPLICATION**

email: hsolis@cityofkingsville.com / Phone (361) 595-8055

PROPERTY INFORMATION: (Please PRINT or TYPE)

Project Address _____ Nearest Intersection _____

(Proposed) Subdivision Name _____ Lot _____ Block _____

Legal Description _____

Existing Zoning Designation _____ Future Land Use Plan Designation _____

OWNER/APPLICANT INFORMATION: (Please PRINT or TYPE)

Applicant/Authorized Agent _____ Phone _____

Email Address (for project correspondence only): _____

Mailing Address _____ City _____ State _____ Zip _____

Property Owner _____ Phone _____ FAX _____

Email Address (for project correspondence only): _____

Mailing Address _____ City _____ State _____ Zip _____

Select appropriate process for which approval is sought. Attach completed checklists with this application.

Annexation Request _____	No Fee	Preliminary Plat _____	Fee Varies
Administrative Appeal (ZBA) _____	\$250.00	Final Plat _____	Fee Varies
Comp. Plan Amendment Request _____	\$250.00	Minor Plat _____	\$100.00
Re-zoning Request _____	\$250	Re-plat _____	\$250.00
SUP Request/Renewal _____	\$250	Vacating Plat _____	\$50.00
Zoning Variance Request (ZBA) _____	\$250	Development Plat _____	\$100.00
PUD Request _____	\$250	Subdivision Variance Request _____	\$25.00 ea

Please provide a basic description of the proposed project:

I hereby certify that I am the owner and /or duly authorized agent of the owner for the purposes of this application. I further certify that I have read and examined this application and know the same to be true and correct. If any of the information provided on this application is incorrect the permit or approval may be revoked.

Applicant's Signature _____ Date: _____

Property Owner's Signature _____ Date: _____

Accepted by: _____ Date: _____

Application Check List for a Re-Zoning

The following must be submitted prior to the application deadline. Otherwise, the application will be deemed incomplete and may result in unnecessary delays: (Please ✓ when complete)

Site and landscape plans: 1 full size and 15 - 11"x17" reductions (copies from PMT reduction)

- ___ 1. A written description of the requested zoning district and the proposed use.
- ___ 2. A site plan showing the location, dimension, material and configuration of all existing buildings, structures and other improvements.
- ___ 3. The lot size in square feet and the dimensions thereof.
- ___ 4. The land uses surrounding the lot(s) for which site plan approval is being sought.
- ___ 5. The zoning on the lots and parcels surrounding the lot(s) for which site plan approval is being sought.
- ___ 6. Such additional information as the city planner may deem pertinent and essential to the application.

Please note that this process can take up to 100 days.

(as of 17 Jun 2024)

Historical Development Board Review Application

Applicant: _____

Address: _____

Contact: Cell: _____ Home: _____

Email: _____

Property Owner: _____

Address: _____

Contact: Cell: _____ Home: _____

Property Location and Description: _____

Description of Work: _____

Contractor: _____

Contact: Cell: _____ Home: _____

Email: _____

Documents Required:

1. Sketch, Drawing, Plans, Site Plans, Mock-ups
2. Photographs (Historic, Current, Surrounding Structures)
3. Materials List or Samples
4. Proof of Ownership
5. Letter of Representation and Work Approval from Property Owner (If Applicable)

I certify that this information and the additional information submitted to the Planning Department is correct and that the work will be completed as described, as approved by the Historical Development Board and in accordance with applicable codes.

(Applicant) Print Name: _____

Signature: _____ Date: _____

Hearing Date: _____ Approved Disapproved with conditions Disapproved

- Meetings are held at City Hall, Helen Kleberg Groves Community Room, 400 W King Ave.
- If the Board disapproves the application with recommended changes, the applicant has 5 days to inform the City if he/she accepts the changes.
- If the application is disapproved or if the applicant does not accept all recommendations, he/she may appeal the Boards decision by informing the City within the 5 day period.
- The Board only hears cases when the owner is present or represented.
- Call 361-595-8055 for information.



CITY OF KINGSVILLE
ENGINEERING DEPARTMENT
400 WEST KING AVENUE
KINGSVILLE, TX 78363
PHONE:361-595-8007 Fax:361-595-8064

OFFICE USE

Floodplain Permit Number: _____
 Building Permit Number: _____
 Fee Paid: _____ Receipt #: _____
 Date Filed: _____
 Approved: YES NO

**FLOODPLAIN DEVELOPMENT PERMIT
 AND APPLICATION FORM**

OWNER AND PROPERTY INFORMATION				
Applicant/Owner name:		Phone:		
Address:		Fax:		
City:	State:	Zip:		
Engineer/Contractor Name:		Phone:		
Address:		Fax:		
City:	State:	Zip:	Email:	
PROJECT INFORMATION				
Project address:				
Legal description of property:				
Proposed project: (circle one)	New structure	Addition	Remodel	Mobile home
Attached garage	Accessory structure	Fill	Excavation	Change of use
Other (describe):				
Description of development:				
SUBMITTAL REQUIREMENTS (check items included with application)				
<input type="checkbox"/> Construction and material specifications		<input type="checkbox"/> Location map		
<input type="checkbox"/> Site plan		<input type="checkbox"/> Pre-construction Elevation Certificate (for new structures)		
REMODELS AND REDEVELOPMENT ONLY				
Cost of improvement for this project: (submit itemized cost list, or projected appraised value upon completion)				
Value of structure: (submit current (within 1 year) appraiser's valuation of structure)				
Cumulative value of improvements:				
Substantial improvement:	Yes	No	(Yes, if cost of project 50% of appraised valuation)	

Floodplain Development Permit and Application Form

FLOODPLAIN INFORMATION					
Note to Applicants: Fill out as much information as possible. If you have questions, or need assistance filling out this form, contact the City of Kingsville Planning Department.					
FEMA Flood Zone Designation	A	AE	AO	X (shaded)	X (unshaded)
Base Flood Elevation:			NGVD (29)	NAVD (88)	
Required Flood Protection Elevation:			NGVD (29)	NAVD (88)	
Floodway:	Yes	No	(If yes, please submit No Rise Certification)		
REGULATORY REQUIREMENTS					
Structure is:	elevated	flood-proofed	vented	n/a	
Elevation Certificate:	Yes	No			
If flood-proofed, describe method:					
Lowest floor elevation:			NGVD (29)	NAVD (88)	
Elevation of garage slab:			NGVD (29)	NAVD (88)	
Lowest elevation of HVAC equipment: (and other mechanical equipment)			NGVD (29)	NAVD (88)	
Enclosed area (not flood-proofed or elevated)				square feet	
Number of vents:			Area of vents:	square inches	
FOR STRUCTURES: Attach building plans showing foundation design, flood elevation, floor elevations, HVAC and other mechanical equipment elevations, size and location of vents, flood-proofing design and other relevant information that address those standards set forth in Section 15-4-5. A pre-construction elevation certificate is also required.					
FOR SITE WORK: Attach site and grading plans and other relevant information.					
Certification: I certify that the above information is correct and agree to construct this building in accordance with the plat, building plans and specifications submitted, and in strict compliance with all the provisions of the Zoning Ordinance, Building Code, of the City of Kingsville.					
Signature of applicant:				Date:	
Printed name:					
Signature of Floodplain Administrator:				Date:	
Comments:					

Last Update 3/2024



**CITY OF KINGSVILLE
LICENSE APPLICATION FOR CONTRACTORS**

LICENSES ARE VALID FROM DATE OF ISSUANCE TO DECEMBER 31

BUSINESS NAME: _____

BUSINESS ADDRESS: _____

BUSINESS TELEPHONE: _____

LICENSEE MAILING ADDRESS: _____

EMAIL: _____

CELL PHONE: _____

LICENSE TYPE: _____

METHOD OF PAYMENT: WE ONLY ACCEPT CHECKS / MONEY ORDERS / DEBIT, MASTERCARD OR VISA

LICENSE FEES	
GENERAL CONTRACTOR	\$125 .00
(SIGN, DEMOLITION, SWIMMING POOL, FOUNDATION AND HOUSE MOVING)	
IRRIGATION CONTRACTOR	\$95.00

- 1. MECHANICAL, ELECTRICAL AND PLUMBING CONTRACTORS MUST SHOW THEIR DRIVER'S LICENSE, LIABILITY INSURANCE AND TRADE LICENSE.**
- 2. NO LICENSE WILL BE ISSUED UNTIL PAYMENTS ARE RECEIVED.**
- 3. APPLICATION MUST BE FILLED IN COMPLETELY BEFORE RECEIVING A LICENSE.**
- 4. RATES CAN NOT BE PRO-RATED.**

Phone: (361) 595-8019 / email: tcavazos@cityofkingsville.com

This form available on our website: <https://www.cityofkingsville.com/departments/planning-and-development-services/>

Application Check List for Special Use Permits

The following must be submitted prior to the application deadline. Otherwise, the application will be deemed incomplete and may result in unnecessary delays: (Please ✓ when complete)

Site and landscape plans: Applicant must provide 15 - 11"x17" or 8 ½"x11" copies of the plans, plus the following:

- ___ 1. Written description of the use i.e. hours of operation, scope of work, number of employees, etc...
- ___ 2. The location, dimension, material and configuration of all buildings, structures and other improvements.
- ___ 3. The location and extent of usable open space.
- ___ 4. The location, access and other dimensions of proposed off-street parking and loading facilities and the number and configuration of spaces to be provided.
- ___ 5. The location, dimensions and materials of sidewalks, driveways and other impervious surfaces.
- ___ 6. The location and intensity of illumination of any illuminated areas.
- ___ 7. The proposed use of open space.
- ___ 8. A landscaping plan, which shall include existing and proposed landscaping on both the subject property and adjacent public areas and including an installation schedule.
- ___ 9. The location of all utilities, including electric lines, storm drainage, sanitary sewers and water service.
- ___ 10. The location and extent of required setbacks and yards.
- ___ 11. The elevation of all buildings and structures to depict height.
- ___ 12. The lot size in square feet and the dimensions thereof.
- ___ 13. Any areas proposed for outdoor storage, refuse collection, exterior mechanical equipment, exterior communication devices and utility apparatus.
- ___ 14. The dimensions, location and landscaping of required landscape/buffer setbacks and screening.
- ___ 15. The land uses surrounding the lot(s) for which site plan approval is being sought.
- ___ 16. The zoning on the lots and parcels surrounding the lot(s) for which site plan approval is being sought.
- ___ 18. Such additional information as the Director of Development Services may deem pertinent and essential to the application.

Please note that this process can take up to 100 days.

Also, make sure you contact 595-8020 for information on City-required inspections and certificate of occupancy.

GENERAL PERMIT INFORMATION

What is a permit? A permit is a written notice authorizing an owner or contractor to proceed with work (construction, repairs, etc.) after paying the permit fee.

Building Permit Process

Who needs a permit?

A permit is issued to an owner or a contractor which allows him/her to complete work in the City of Kingsville. All contractors **must be** registered with the City of Kingsville.

Homeowner's Permit

A homeowner may purchase a permit, with the exception of an electrical permit, mechanical permit and a plumbing permit, which must be purchased by a licensed contractor and the work completed by that contractor. When purchasing a homeowner's permit, the homeowner is certifying that they own and are now living at the dwelling for which the permit is being issued **and** that the work being performed is by the homeowner or their immediate family; he/she also also understands that for the purpose of the permit, "immediate family" is limited to his/her parents, child or child's spouse.

Type of Permits

The following permits are the most common. Please call 361-595-8019 to determine if your intended work requires a permit.

Building / Structure – additional square footage, relocating a structure, remodeling, repairing

Curb Cuts / Driveway – curb cuts for the creation of a driveway or a ramp, new driveways, etc.

Electrical – new square footage, repairs, change outs, etc.

Gas - repairs

Mechanical – new square feet, repairs, change outs, etc.

Meter Inspections- required for service connection (new, temporary, etc.)

Plumbing – new square feet, remodeling, repairs, etc.

Roofing - All repairs or re-roofs

REMEMBER TO GET YOUR PERMITS. IF YOU ARE CAUGHT WORKING WITHOUT A PERMIT, YOU WILL GET DOUBLE-FINED OR CITED.

1. PROOF OF OWNERSHIP **MUST BE PROVIDED** BEFORE ANY PERMIT CAN BE ISSUED.
2. ALL PROPERTIES MUST BE A "LEGAL LOT" BEFORE A PERMIT CAN BE ISSUED.



**CITY OF KINGSVILLE
Planning Department
Building Permit Application**

Phone: (361) 595-8019 / email: tcavazos@cityofkingsville.com

DATE:	PERMIT#:	APPROVED BY:
JOB ADDRESS:		
OWNER'S NAME: LAST:	FIRST:	M:
MAILING ADDRESS:		PHONE NO:
CITY:	STATE:	ZIP CODE:
CONTRACTOR: *		PHONE #:
SIZE/TYPE OF WORK: Square Feet: _____ <input type="checkbox"/> New <input type="checkbox"/> Remodel		
DESCRIPTION OF WORK:		
VALUATION OF WORK: \$		PERMIT FEE: \$
<p>* All contractors <u>must</u> be registered with the City of Kingsville</p> <p>NOTICE</p> <p>SEPARATE PERMITS ARE REQUIRED FOR ELECTRICAL, PLUMBING, HEATING, VENTILATING OR AIR-CONDITIONING. ALL CONTRACTORS ARE RESPONSIBLE FOR DISPOSING OF THEIR OWN DEBRIS AT THE SANITARY LANDFILL ON CR 2130. THIS PERMIT BECOMES NULL AND VOID IF WORK OR CONSTRUCTION AUTHORIZED IS NOT COMMENCED WITHIN SIX MONTHS, OR IF CONSTRUCTION OR WORK IS SUSPENDED OR ABANDONED FOR A PERIOD OF 6 MONTHS AT ANY TIME AFTER WORK HAS COMMENCED.</p>		
SIGNATURE _____		DATE _____
<p>"HOMEOWNER" APPLICANTS ONLY: I HEREBY CERTIFY THAT I OWN AND AM NOW LIVING AT THE DWELLING FOR WHICH THIS PERMIT IS BEING ISSUED, AND THAT THE WORK IS BEING PERFORMED BY ME OR A MEMBER OF MY IMMEDIATE FAMILY. I UNDERSTAND THAT, FOR THE PURPOSES OF THIS APPLICATION, MY IMMEDIATE FAMILY IS LIMITED TO MY PARENT, CHILD OR CHILD'S SPOUSE.</p> <p align="center">INITIAL HERE _____ (sign Homeowner Permit Acknowledgement Form)</p>		

FOR OFFICE USE ONLY

CURRENT ZONING FOR LOCATION:	IS ZONING APPROPRIATE FOR USE REQUIRED: <input type="checkbox"/> Yes <input type="checkbox"/> No
SETBACK REQUIREMENTS VERIFIED: <input type="checkbox"/> Yes <input type="checkbox"/> No	ARE SETBACK REQUIREMENTS MET: <input type="checkbox"/> Yes <input type="checkbox"/> No
IS THE PROPERTY IN THE AICUZ/CCLUA**: <input type="checkbox"/> Yes <input type="checkbox"/> No	DOES IT COMPLY WITH THE AICUZ/CCLUA**: <input type="checkbox"/> Yes <input type="checkbox"/> No
PROPERTY EASEMENT VERIFIED: <input type="checkbox"/> Yes <input type="checkbox"/> No	DIMENSION OF EASEMENT:
AICUZ/CCLUA** DEED NOTIFICATION: <input type="checkbox"/> Yes <input type="checkbox"/> No	** CONTROLLED COMPATIBLE LAND USE AREA (JAZB)

This form available on our website: <https://www.cityofkingsville.com/departments/planning-and-development-services/>

Last revised 12 Jul 2024

Show NORTH arrow on (PLOT PLAN)

LOT SIZE:

1. Width of lot _____ (in ft/in) 2. Length of lot _____ (in ft/in)

BUILDING SETBACKS (see City of Kingsville Ordinance Chap XV, Art 6, App B, Section 1 or 2):

1. Front _____ 2. Right Side _____

3. Left Side _____ 4. Back _____

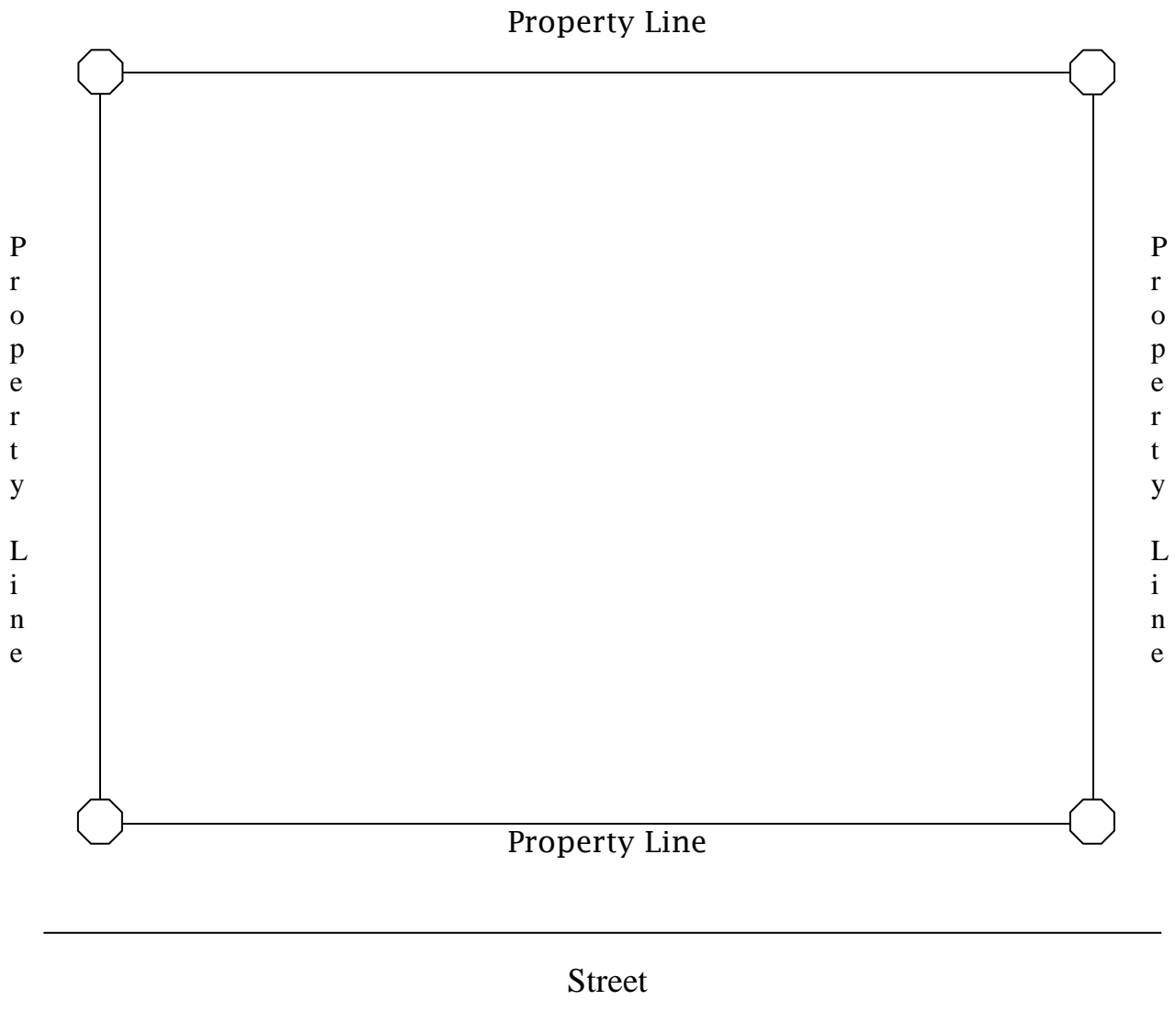

Materials and Construction Details

Part I: Type of Home (please specify) _____

Part II: Foundation

- 1. Type: Post Tension ___ Pier & Beam ___ Steel Reinforcement ___ Crawl Space ___
Other _____
- 2. Anchorage: Bolts ___ Straps ___ Other ___ _____

Part III: Open Framing

- 1. Floor framing: Specs: _____ Grade: _____ Size: _____ Spacing: _____
Span: Conventional ___ Other _____
- 2. Subfloor: Material: _____ Thickness: _____
Fastening: Nails ___ Other _____
Spacing of Fasteners: ___ On edges ___ Intermediate
- 3. Wall Framing: Load Bearing Walls: Size: _____ Spacing: _____
Non-Load Bearing Walls: Size: _____ Spacing: _____
All blocking, plates, lintels, headers and bracing _____ Wind Bracing: _____
- 4. Roof Framing: Trusses ___ Rafter Size: _____ Spacing: _____ Span: _____
Specs: _____ Grade: _____
Ceiling Joists: Size: _____ Span: _____ Specs: _____ Grade: _____

Part IV: Roofing & Flashing

- 1. Roof Sheathing: Thickness: _____ Grade: _____
- 2. Attic Ventilation: Ridge & Soffit ___ Other _____
- 3. Flashing: at roof/wall changes ___ at chimneys ___ at doors & windows ___
at porches & thresholds ___ at roof penetration ___

Part V: Mechanical/Electrical/Plumbing

- 1. Electrical: Service Size : _____ Wire Size: _____ Service Location: _____
- 2. HVAC System: Hearing type: _____ Location: _____
Central A/C? ___ Yes ___ No Ductwork: Type: _____ Location: _____
- 3. Plumbing: Water Distribution Material: _____ Vent Size: _____
Location: _____
Water: On-site Well ___ Public System ___
Waste Water: On-Site Septic ___ Public System ___

Comments _____

SAMPLE OF ACCEPTED DRAWINGS

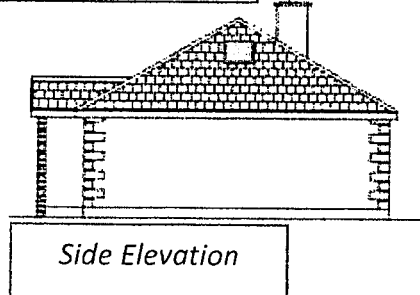
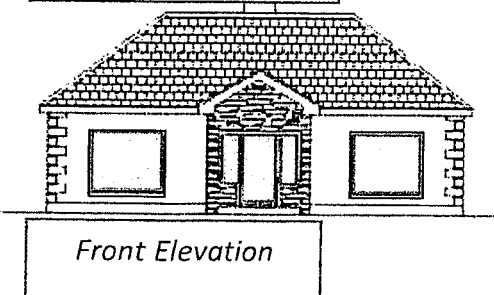
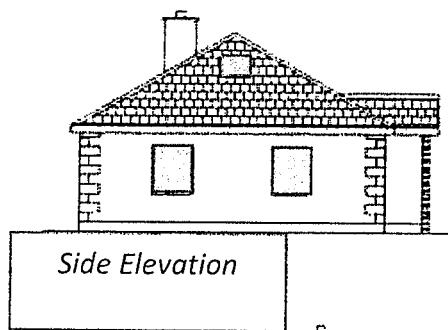
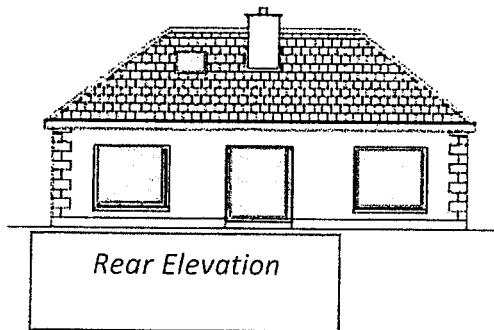
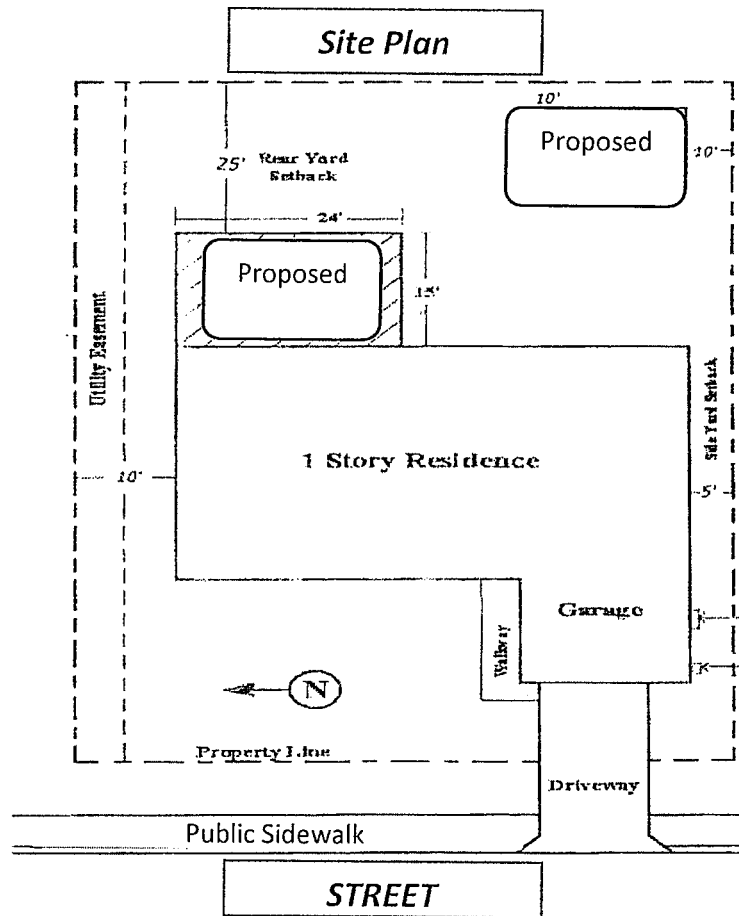

BUILDING PERMIT CONDITIONS

These permit conditions are intended to highlight important building-related regulations. They **do not** represent a comprehensive list of building laws. For additional information, please refer to the appropriate City and County building ordinances.

GENERAL

1. The building permit shall be posted on the job site in public view, along with a list of standard and special permit conditions in English and Spanish.
2. After a permit has been issued, it shall be unlawful for any person to modify or alter any plans without the prior written approval of the Building Official.
3. Work under any City Permit shall begin within 6 months and **must be completed** within 12 months after the permit is issued, unless an extension is granted in writing by the Building Official.
4. A permit may be revoked by the Building Official if work has stopped for 30 days.
5. It is unlawful to continue work when a permit has been suspended or revoked or when a "Stop Work Order" has been issued.
6. The City may examine the work and the building as often as necessary and may order any change in the work necessary to comply with City Regulations.
7. The City must be notified 48 hours in advance of required building inspections.
8. Construction noise levels must conform to the City Ordinance, entitled Article 6: "Noise Control."

PRIVATE PROPERTY SITE MANAGEMENT

1. The building site shall be kept clear of all rubbish, including trash and construction-related debris.
2. The location and screening of all dumpster and portable sanitation facilities shall be approved by the City and noted on the site plan. No dumpsters or sanitation facilities shall be located in the public right-of-way.
3. Dumpsters may not be used as collection points for others construction sites or for discarding perishable waste.
4. Any required erosion and sediment control plan and/or tree protection plan must be maintained throughout the course of the permitted work.
5. Dust associated with demolition must be controlled by metered water spray. Dust associated with stone cutting must be controlled by a wet saw.
6. No commercial signs, except real estate signs, shall be posted on the site.

PUBLIC PROPERTY SITE MANAGEMENT

1. No person shall store or allow an accumulation of refuse, excavation or construction debris, or any construction materials on any public right-of-way including, but not limited to, streets, sidewalks, curbs, gutters, and grassy areas. Accumulation of mud or dirt must be removed from the public right-of-way daily. Public sidewalks must be kept passable at all times, unless otherwise approved by the City.
2. Unattended construction pits and trenches in the public right-of-way shall be clearly marked and covered.
3. Any repairs, alterations, modifications to or closure of any street or sidewalk that prohibits the free passage of vehicles or pedestrians shall be clearly marked with barricades, safety barriers, or both and may not exceed ten (10) days, unless specifically authorized, in writing, by the Director of Public Works.
4. No vehicles may be parked on City sidewalks, driveway aprons or on any area between the curb and/or gutter and sidewalk.
5. Construction vehicles must park on the building site or on the side of the street directly in front of the building site, whenever possible.
6. **NO** construction trailers or other equipment shall be parked or stored on City streets or in the City right-of-way between the hours of 10 pm and 6 am.

7. Public property site management shall be compliant with the American with Disabilities Act.

AFFIDAVIT

I have read the above requirements and am aware that not following them could lead to a "Stop Work Order," fines or revocation of my City Building Permit.

Applicant's Signature

Print Name

Date



City of Kingsville

Permit Instructions & Application for Driveways/Sidewalks/Parking Lots

email: tcavazos@cityofkingsville.com / Phone (361) 595-8019

INSTRUCTIONS: Submit one (1) application; you may be required to submit **architectural/engineering plans** upon request and any supplemental information to ensure compliance with the City of Kingsville Code of Ordinances. **When submitting electronic plans, please place job description (“Driveways/Sidewalks/Parking Lots”) in the "subject" line.** Email plans to: tcavazos@cityofkingsville.com.

Submitted drawings **must include**:

- Scaled drawing of site plan with driveway/sidewalk/parking lot location, size design and engineered standards (Architectural Plans)
- Weight limit (may require Engineering Plans)
- If installed over the public right-of-way, written permission from the City’s Public Works Director is required

Permit applicants are required to meet conditions for all of City of Kingsville’s ordinances, some of which may not be listed below. Ordinances can be found on our city website at:

https://library.municode.com/tx/kingsville/codes/code_of_ordinances

Common Driveway/Sidewalk/Parking Lot Ordinances:

Driveways, Street & Roadway Standards; Access to Businesses (Sec. 15-6-108)
 Driveway and Permit Construction Requirements (Sec. 9-10-20 through 24)
 Regulations for Access Driveways to State Highways Appendix, (Sec. 1-4)
 Restricted construction; Alteration, Sidewalks, and Driveways Required (Sec. 9-10-4 and 9-10-5)
 Alleys, Streets, & Pavement Cuts (Sec. 9-10-35, 36, 37)
 Curb & Gutter (Sec. 15-3-50 (A&B))
 Sidewalks (Sec. 15-3-51)
 Landscapes in Parking Lots (Sec. 15-8-8, 9, 10)
 Violations/penalties (Sec. 15-8-18)

Caution: Lot lines do not normally coincide with curbs, grader ditches, or sidewalks, and many fences are not located on lot lines. If you are unsure of the exact location of the lot lines, please have a land surveyor locate them.

The City of Kingsville **is not** responsible for locating pins or surveying your property.

Fees for Driveways/Sidewalks/Parking Lots: See City of Kingsville Permit Fee Schedule.

Inspections: Inspections can be scheduled by calling the Building Services at (361) 595-8019 within 24 hours. Please provide permit number and address of the property.

This form available on our website: <https://www.cityofkingsville.com/departments/planning-and-development-services/>



City of Kingsville

Application for Driveways/Sidewalks/Parking Lots

email: tcavazos@cityofkingsville.com / Phone 361-595-8019

Project Information (Please Print)

Project Address: _____

Legal Description: _____

Check work use and type: ___ Residential ___ Commercial ___ Driveway ___ Sidewalk ___ Parking Lot

Check work detail: ___ New Driveway ___ Addition to existing driveway ___ Remove & replace driveway

___ New Approach **Material:** ___ Concrete ___ Asphalt ___ Pavers ___ Stone Base

Paving Thickness: ___ Driveway ___ Approach **Stone Base Thickness:** ___ Driveway ___ Approach

Name and Address of Property Owner (Please Print)

Property Owner Name: _____ Phone Number: _____

Street Address: _____

City: _____ State: _____ Zip Code: _____

Email Address: _____

Name and Address of Applicant or Contractor (If different from Owner; Please Print)

Company Name: _____

Contact Person: _____ Phone Number: _____

Street Address: _____

City: _____ State: _____ Zip Code: _____

Email Address: _____

The undersigned hereby makes an application to construct a driveway/sidewalk/parking lot as specified herein and as shown on the drawings, and agrees to comply with the provisions of the Building and Zoning Codes, Engineering, Design Standards of the City of Kingsville, and previous info provided under permit instructions attached whether the same is specified herein or not.

Applicant Signature: _____ Date: _____

Property Owner's Signature: _____ Date: _____

Engineering Dept Approval: _____ Date: _____

Building Official Approval: _____ Date: _____

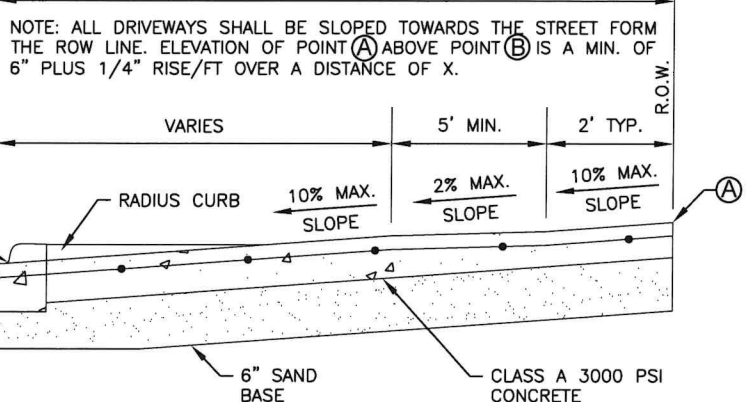
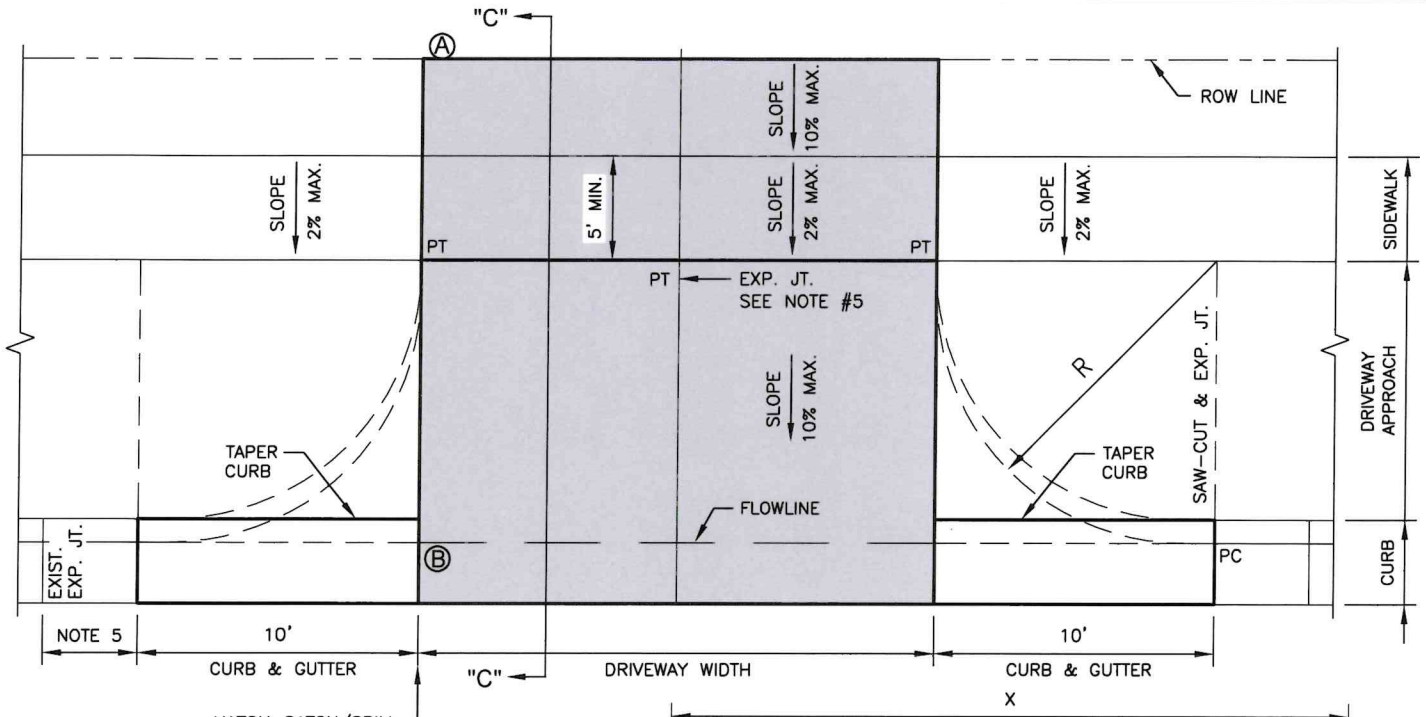

CROSS SECTION "C" - "C"

USER	THICKNESS	REINFORCEMENT	DRIVEWAY WIDTH
RESIDENTIAL DRIVEWAYS; DRIVEWAYS FOR PASSENGER VEHICLE PARKING LOTS	6" MIN.	#4 BARS @ 18" O.C.E.W.	9' MIN. - 24' MAX.
NON-RESIDENTIAL	7" MIN.	#4 BARS @ 12" O.C.E.W.	24' MIN. - 35' MAX.

- DRIVEWAY RADIUS ENDS ARE OPTIONAL.
- DRIVEWAY WIDTHS AND RADII DIMENSIONS, ONE/TWO WAY TRAVEL REQUIREMENTS, AND GEOMETRIC LAY-OUT ARE HIGHLY VARIABLE SUBJECT TO SITE SPECIFIC CONDITIONS AND REQUIREMENTS.
- "ZERO" CURB AT PT. TRANSITIONS SIDEWALK TO MATCH DRIVEWAY.
- PLACE AN EXPANSION JOINT DOWN THE CENTER OF DRIVEWAYS WIDER THAN 30 FEET.
- IF DIMENSION IS LESS THAN FIVE FEET, REMOVE CURB AND GUTTER TO EXISTING EXPANSION JOINT AND POUR MONOLITHICALLY WITH DRIVEWAY.
- IF THE BASE IS OVER-EXCAVATED WHERE THE CURB AND GUTTER WAS REMOVED, BACKFILL WITH CONCRETE MONOLITHICALLY WITH DRIVEWAY.
- DRIVEWAYS ARE TO BE LOCATED NO CLOSER TO THE CORNER OF INTERSECTING RIGHTS OF WAY THAN 60 PERCENT OF PARCEL FRONTAGE OR 100 FEET; WHICHEVER IS LESS.
- DRIVEWAYS SHALL NOT BE CONSTRUCTED WITHIN THE CURB RETURN OF A STREET INTERSECTION.
- WHILE THE PROPERTY OWNER REMAINS RESPONSIBLE FOR GRADE BREAKS WITHIN PRIVATE PROPERTY, THE FIRE DEPARTMENT SHOULD BE CONSULTED WHERE THE DRIVEWAY IS ESSENTIAL TO EMERGENCY VEHICLE ACCESS AND "C2" IS GREATER THAN 15%.
- USE 1/2" ASPHALT BOARD OR OTHER APPROVAL MATERIAL FOR CURB AND GUTTER EXPANSION JOINTS, SIDEWALKS, AT THE ROW LINE, AND AT MIDWIDTH (NOTE 4).

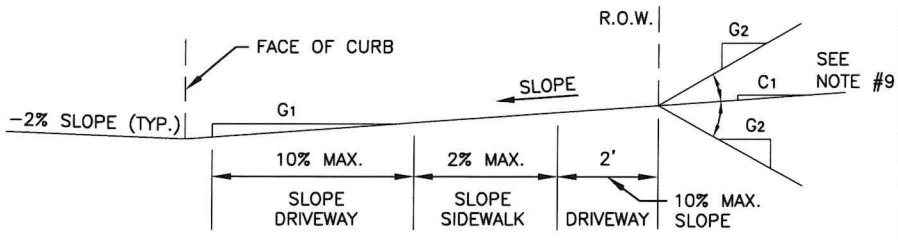

DRIVEWAY VOLUME (ADT)	D= GRADE CHANGE	
	STD.	MAX.
> 1,500	0%	3%
500 - 1,500	3%	6%
< 500	6%	15%

REVISED
05-31-2023

SHEET 1	CITY OF KINGSVILLE	Drawn by: J. RAMIREZ		CITY OF KINGSVILLE ENGINEERING DEPARTMENT 400 West King Kingsville, Texas 78363 Office 361.595.8007 Fax 361.595.8035
	CONCRETE DRIVEWAY DETAILS	Date: 04-12-2023		
		Checked by: R. MORA		
		Job:		
		Scale: AS NOTED		

Sidewalk Details

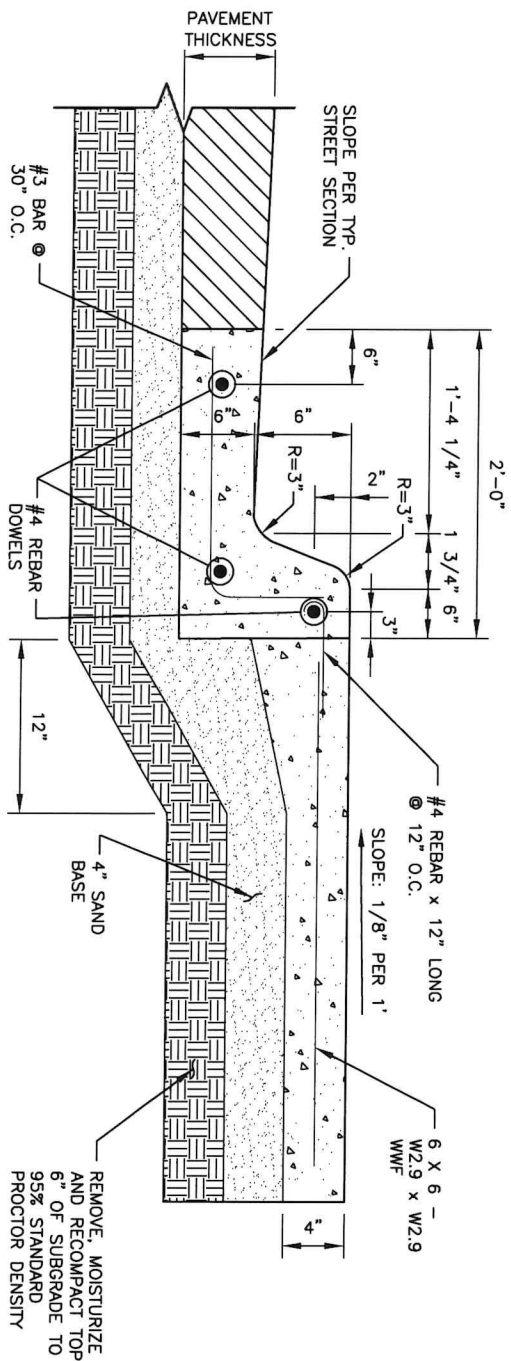

A SECTION
1 N.T.S.

1 CONCRETE SIDEWALK DETAIL
1 N.T.S.

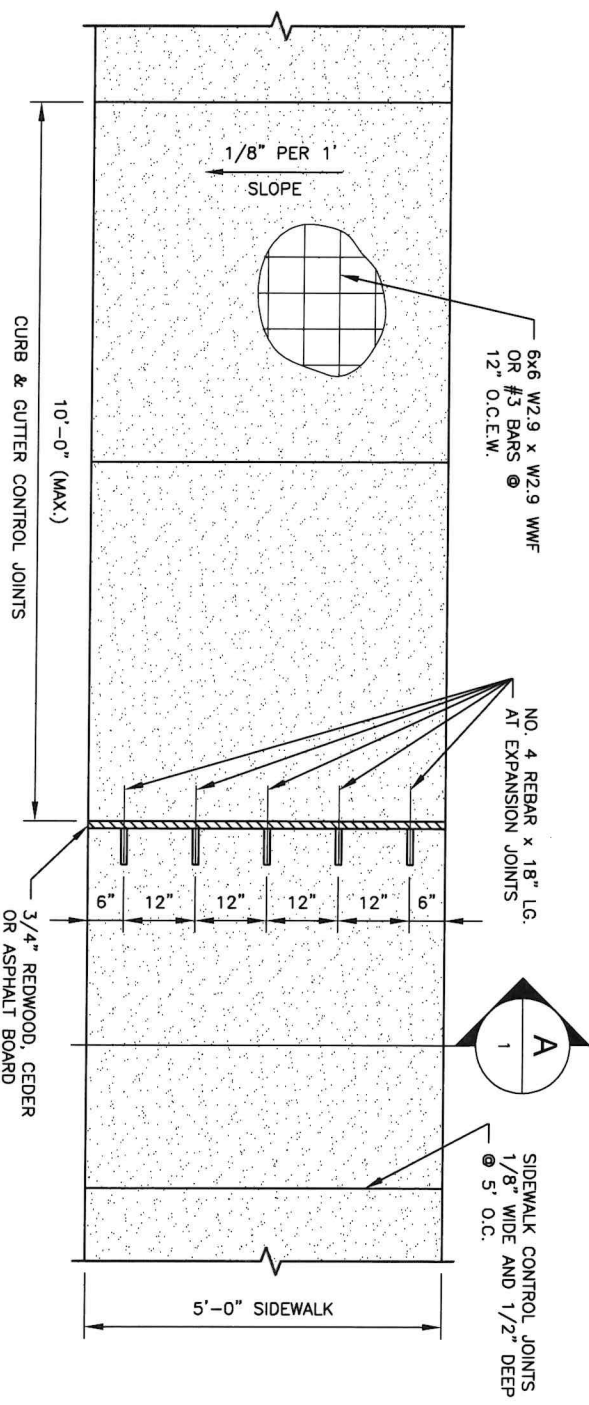

A SECTION
1 N.T.S.

REVISED
05-31-2023

CITY OF KINGSVILLE SIDEWALK DETAILS

Drawn by: J. RAMIREZ
Date: 04-12-2023
Checked by: R. MORA
Job:
Scale: AS NOTED



CITY OF KINGSVILLE
ENGINEERING DEPARTMENT
400 West King
Kingsville, Texas 78363
Office 361.595.8007
Fax 361.595.8035

Sidewalk Details

1
1
N.T.S.
DRIVEWAY CURB BREAK DETAIL

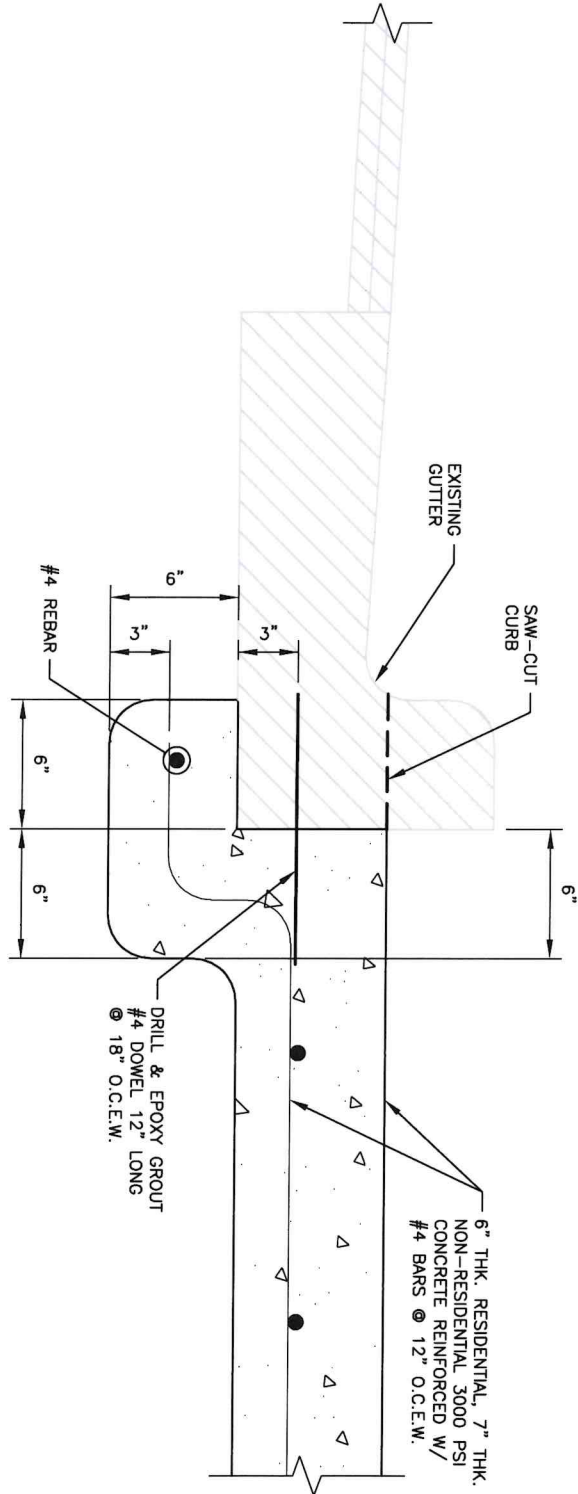

REVISED
05-31-2023

CITY OF KINGSVILLE
SIDEWALK DETAILS

Drawn by: J. RAMIREZ
Date: 04-12-2023
Checked by: R. MORA
Job:
Scale: AS NOTED



CITY OF KINGSVILLE
ENGINEERING DEPARTMENT
400 West King
Kingsville, Texas 78363
Office 361.595.8007
Fax 361.595.8035

SHEET
1



CITY OF KINGSVILLE

Fence Application

Phone: (361) 595-8019 / email: tcavazos@cityofkingsville.com

Property information:			
Project Address:		Legal Description:	
Zoning District:		Historic District: <input type="checkbox"/> Yes <input type="checkbox"/> No	
Information:			
Owner:		Contractor:	
Mailing Address:		Address:	
Phone:		Phone:	
E-mail:		E-mail:	
Description of Work:			
Land Use (check box)	<input checked="" type="checkbox"/> Residential	<input checked="" type="checkbox"/> Commercial	
Types of Material: (check box)			
<input checked="" type="checkbox"/> Chain Link	<input checked="" type="checkbox"/> Vinyl	<input checked="" type="checkbox"/> Stone	
<input checked="" type="checkbox"/> Solid Wood	<input checked="" type="checkbox"/> Wrought Iron	<input checked="" type="checkbox"/> Concrete Block	
<input checked="" type="checkbox"/> Brick	<input checked="" type="checkbox"/> Other		
Job Valuation: \$			
Total Job Valuation: \$			
Required Documentation:			
<input type="checkbox"/> Site Plan with fence location and height indicated (See page 2)			
<input type="checkbox"/> Show Property Lines and Setbacks (See accepted drawings on page 3)			
<input type="checkbox"/> Image or drawing depicting fence design			
Signature (Applicant):		Date:	
City of Kingsville Only			
Permit Fees: \$35		Date Paid: _____	
Permit #			
Remarks:			

Approved by: _____		Date: _____	

Fence Site Plan

Alley Way (if applicable)

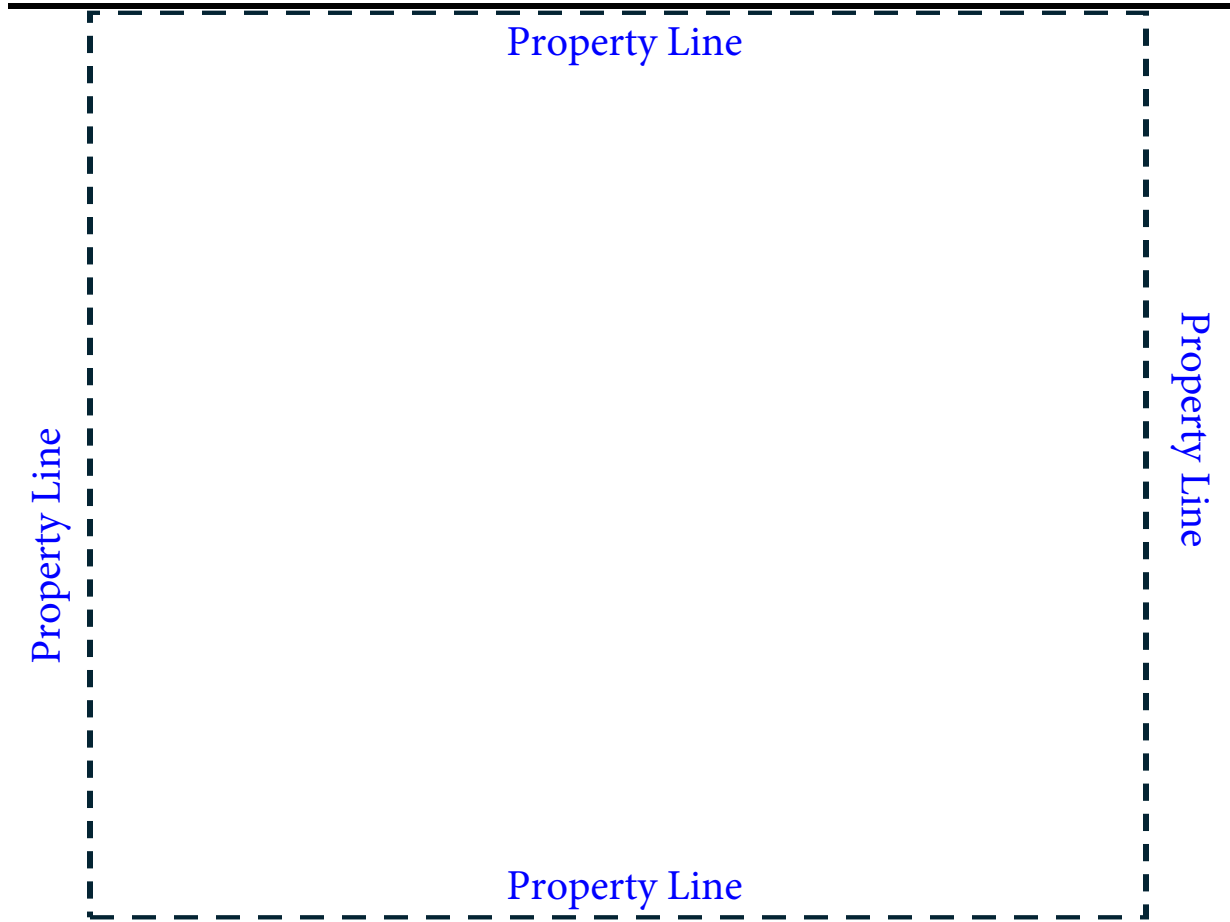

Public Sidewalk

Street



Picture of Fence

Sample of Accepted Fence Site Plan & Picture

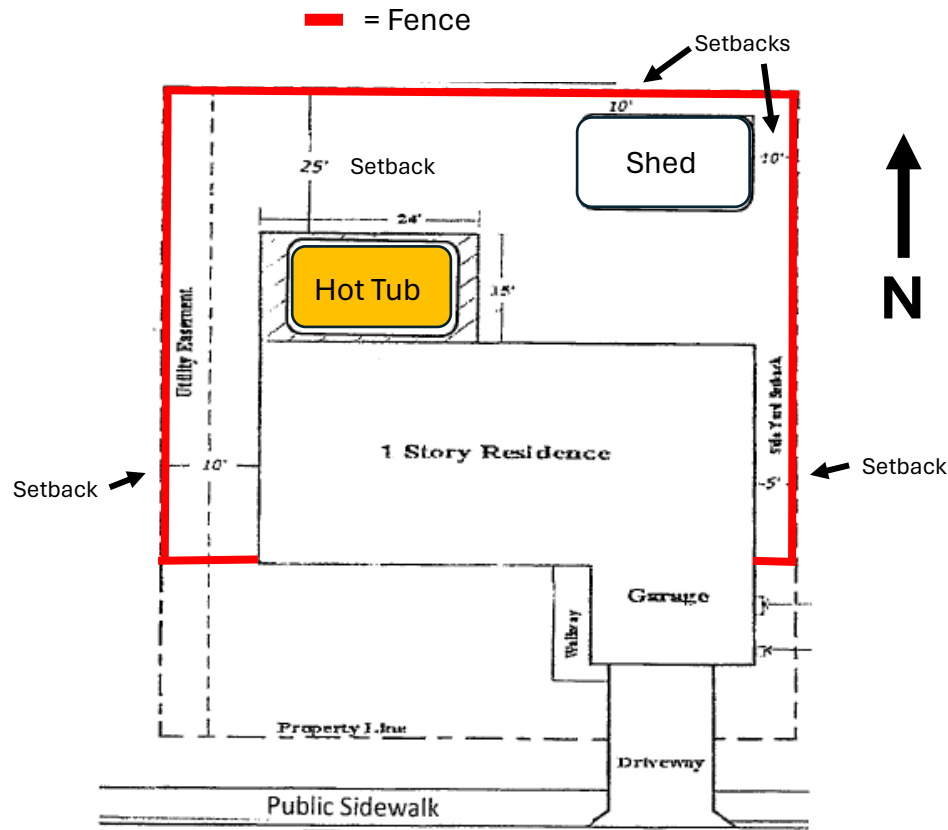

City of Kingsville Fence Ordinances

https://library.municode.com/tx/kingsville/codes/code_of_ordinances?nodeId=PT2COOR_CHXVLAUS_ART6ZO_USREDI_S15-6-28FERE

- Fence Regulations (Sec. 15-6-28)
- Barbed Wire and Electric Fences (Sec. 13-1-2)
- Fence Maintenance (Sec. 15-1-17)
- Space Requirements Appendix B, Space Requirements for Non-Residential Use Sec. 1 & 2 (Article 6, Appendix B)

PART 2 - CODE OF ORDINANCES
Chapter XV - LAND USAGE
ARTICLE 8. LANDSCAPING POLICY

ARTICLE 8. LANDSCAPING POLICY

Sec. 15-8-1. General.

- (A) The information in this article is intended to define the technical design criteria needed to achieve the landscape policy goals of the City of Kingsville, Texas. These rules apply to all land located within the city limits and to those projects outside the city limits which have agreed to comply with these provisions as part of a contractual agreement with the city.
- (B) The site plan approval process is outlined in the City Code of Kingsville. Procedures for inspection and enforcement are also found in the City Code.
- (C) Appeals concerning the enforcement of these rules shall be brought to attention of the Director of Planning.
(Ord. 97040, passed 11-24-97; Ord. 98027, passed 11-28-98; Ord. 2005-13, passed 4-11-05)

Sec. 15-8-2. Reserved.

Sec. 15-8-3. Exemptions.

(Reserved)

Sec. 15-8-4. Specified by the city code.

The code identifies certain types of development projects which are specifically noted as being exempt from the Landscape Provisions of the Code, as follows, to wit:

- (A) Single family residences where only one such structure is constructed per lot.
- (B) Duplex residences (containing fewer than six bedrooms per lot) where only one structure is constructed per lot.
- (C) Restoration of damage to a structure within the 12 months subsequent to a fire, explosion, flood, tornado, riot or accident of any kind.
- (D) Building restoration for historic structures.
- (E) Remodeling of any structure where the front and side exterior walls remain in the same location. Two variations on this condition are illustrated in Figure 2-1.

(Ord. 97040, passed 11-24-97; Ord. 2005-13, passed 4-11-05)

Sec. 15-8-5. Not clarified by City Code.

Other types of projects are exempt for other reasons. These include:

- (A) Projects on federal and state owned land.
- (B) Carports, canopies and free-standing covers supported by columns less than two feet wide and four feet long.

(Ord. 97040, passed 11-24-97; Ord. 2005-13, passed 4-11-05)

Sec. 15-8-6. Basic requirements.

The following text explains the basic landscape requirements common to all commercial sites under the jurisdiction of the City Code.

(Ord. 97040, passed 11-24-97; Ord. 2005-13, passed 4-11-05)

Sec. 15-8-7. Street yard.

(A) Landscape area.

- (1) At least 10% of street yard must be landscaped. Grass areas not using grasses indigenous listed on the Preferred Plant List (see Exhibit A) are not credited as landscaped area except in shaded areas (areas that receive less than six hours of sunlight per day).

(B) Determining street yard.

- (1) The exact configuration of a street yard (or street yards) on a site will depend on how a number of factors interrelate on that site. Among these factors are:
 - (a) Type and location of building walls.
 - (b) Number of streets that border the site.
 - (c) Number, size, and orientation of buildings on the site.
 - (d) Whether there is a building on the site or just a parking lot.
- (2) The street yard area is calculated by finding the total lot square footage which lies between the street right of way line and the front wall of a building or buildings on a site. This street yard boundary extends from the outward most corners of the front wall, parallel to the street until it intersects with the side property lines.
- (3) The building wall line shall include irregular shapes or indentions of the building wall, but exclude unenclosed porches, canopies and exterior columns. Some examples of variations on this concept are illustrated in Figure 2-2.
- (4) On a site or portion of a site used only for parking purposes or as a commercial or private parking lot, the street yard shall consist of the area between the street right-of-way and the back property line.

(C) Drip line credit.

- (1) In order to encourage the preservation and continued growth of smaller trees, the following credit toward landscape area is possible. Each square foot of landscape area which is permeable and within the area encompassed by the drip line of a surveyed tree at least two inches in trunk diameter measured at 4½ feet above the ground, shall count as 1.25 square feet of landscape area.
- (2) The foregoing credit shall be subject to the following limitations:
 - (a) Overlapping drip line area cannot be counted twice.
 - (b) No credit will be given if more than half of the drip line area is impervious.
 - (c) No credit will be given where damaging grade changes within the drip line (of a tree) has occurred.

- (d) In no case can the actual landscape area in the street yard of a lot be less than one-third of the required 10%.
- (D) Street yard trees. Within the area described as street yard in Section 11-12-71 a minimum amount of trees are required to be planted or preserved with at least 60% of the trees planted from the Preferred Plant List (see Exhibit A) to the area. Planted trees shall be no less than 6 feet initial height and no less than 1½ inch caliper measured at 4½ feet above the ground. No more than 50% of planted trees will be from the same genus or species (if more than ten trees are required), as follows:

TOTAL STREET YARD AREA	REQUIRED TREES
1,000—10,000 sq. ft.	1 tree/2,000 sq. ft.
10,000—110,000 sq. ft.	5 trees for first 10,000 sq. ft. plus 1 tree for every 5,000 sq. ft. over 10,000 sq. ft.
over 110,000 sq. ft.	25 trees for first 110,000 sq. ft. plus 1 tree for every 10,000 sq. ft. over 110,000 sq. ft.

- (E) Existing tree credit. All existing surveyed trees over two inches in trunk diameter or tree clusters of at least four one-inch diameter trees preserved within the street yard boundaries may satisfy these requirements one for one. All trees measuring six inches or more in trunk diameter measured at 4½ feet above the ground shall count double toward satisfying these requirements.

(Ord. 97040, passed 11-24-97; Ord. 98027, passed 12-28-98; Ord. 2005-13, passed 4-11-05)

Sec. 15-8-8. Landscape in parking lots.

- (A) Landscape area.
- (1) Four square feet of landscaped area is required for each parking space within a parking lot located in the street yard. Three square feet for each parking space is required for all non-street yard parking lots.
 - (2) This landscape area should occur entirely within the parking lot boundaries as landscaped medians, landscaped islands or as landscaped peninsulas.
- (B) Islands, medians or peninsulas.
- (1) A landscape island, median or peninsula should be located within 100 feet of each entire parking space on a lot. This distance should be measured from the curb line of the landscape island, median, or peninsula and should extend 1 foot into the entire parking space.
 - (2) Grasses not listed on the Preferred Plant List (see Exhibit A) cannot be planted on islands, medians, or peninsulas. At least 60% of the required landscape area must be selected from the Preferred Plant List (see Exhibit A) with no more than 50% of the plants from the species.
 - (3) To provide significant space for the growth of trees planted within these areas, the minimum width for landscaped islands, medians, or peninsulas which contain new trees is eight feet measured from the inside of the curb (see Figure 2-3).
- (C) Trees in parking lots. One tree must be located within 100 feet of each parking space. This requirement should also be considered when designating parking lot landscape area (see Figure 2-4).
- (D) Special provisions for large parking lots. The above paragraphs (B)(1) and (C), in Section 15-8-8, do not apply if this division (D) is required. For parking lots with more than three parking modules, a ten feet minimum width median (measured from inside of curb) will be required for every third parking module. Trees within the median must be located so that one tree shall be located within 50 feet of each parking space adjacent to

the median. No additional islands shall be required to satisfy Section 15-8-8 except for end islands for each parking module (see Figure 2-4.1). All landscape islands and peninsulas must be an eight feet minimum width measured from inside of curb.

(Ord. 97040, passed 11-24-97; Ord. 98027, passed 12-28-98; Ord. 2005-13, passed 4-11-05)

Sec. 15-8-9. Buffering/screening.

- (A) Buffering is a site specific requirement that should be evaluated based on viewer distance and angle of view from the areas or site features requiring buffering. Buffer design should also consider the amount of view obstruction required and the type and mixture of design elements used in the buffer. Buffering is a site specific requirement that shall be between all multi-family (R-3 and above) and commercial and industrial land uses.
- (B) When buffering is required, the installation and maintenance thereafter of a visual screen of one of the following types shall be provided:
 - (1) A solid material and/or masonry fence or wall at least six feet in height.
 - (2) A hedge-like screen of evergreen plant material capable of attaining a minimum height of six feet at maturity, planted initially at a minimum of four feet on center. The plants will be a minimum height of two and one-half feet at time of planting. An irrigation system shall also be installed.
 - (3) Existing vegetation may be used as screening if the following conditions are met:
 - (a) The vegetation area is at least ten feet wide and a limit of construction line is clearly marked on the plans.
 - (b) The area must contain, per 20 linear feet of screen, the equivalent of one large tree (minimum two inch caliper), two small trees (minimum one inch caliper) and six evergreen plants at a minimum height of two and one-half feet with the minimum height attainment at maturity of at least six feet. If an irrigation system is not in place, one must be installed.

(Ord. 97040, passed 11-24-97; Ord. 98027, passed 12-28-98; Ord. 2005-13, passed 4-11-05; Ord. 2006-10, passed 4-10-06)

Sec. 15-8-10. Landscape of other areas.

Landscape of other areas shall include all landscaped areas that are not included as part of the Street Yard, Parking Lots or Buffering requirements.

- (A) Plant selection. At least 90% of the areas shall be planted with species from the Preferred Plant List (See Exhibit A). Up to 10% of the plants may be of a non-preferred variety as long as they are grouped together in a suitable area and can be irrigated separately.
- (B) Turf selection. Areas that receive more than six hours of sunlight per day shall be planted with turf species from the Preferred Plant List (see Exhibit A).

(Ord. 97040, passed 11-24-97; Ord. 2005-13, passed 4-11-05)

Sec. 15-8-11. Soil conditioning and mulching.

- (A) A minimum of three inches of organic mulch shall be added in non-turf areas to the soil surface after planting.

-
- (B) Non-porous material such as sheet plastic shall not be placed under the mulch.
 - (C) A minimum of four inch permeable soil, native or imported, shall be required for turf and landscaped areas.
(Ord. 97040, passed 11-24-97; Ord. 2005-13, passed 4-11-05)

Sec. 15-8-12. Irrigation of landscape areas.

- (A) The owner shall be responsible for the irrigation of all required landscape areas and plant materials, utilizing one or a combination of the following methods:
 - (1) An automatic or manual underground irrigation system (conventional spray, bubblers, drip, emitters, drip tubing, porous pipe and the like with tuft zones separated from planting zones unless otherwise approved;
 - (2) A hose attachment within 100 feet of all required landscape areas and plant materials where there is no road or parking pavement between the hose attachment and landscape area and the site plan area is no larger than 0.5 acre;
 - (3) Landscape areas planted with native grasses and wild flowers may use a temporary and above ground irrigation system and shall be required to provide irrigation only for the first two growing seasons.
- (B) The irrigation methods used shall:
 - (1) Be in place and operational at the time of the landscape inspection; and
 - (2) Be maintained and kept operational at all times to provide for efficient water distribution;
 - (3) Landscape working plans shall indicate, by a detail, a drawing or by specification in a note on the site plan, the nature and location of irrigation which will be used and the location of emergency irrigation system shut-off valve;
 - (4) No irrigation shall be required for undisturbed natural areas or undisturbed existing trees.

(Ord. 97040, passed 11-24-97; Ord. 98027, passed 12-28-98; Ord. 2005-13, passed 4-11-05)

Sec. 15-8-13. Protection of landscape area.

- (A) All landscape areas adjacent to vehicular use areas shall be protected with concrete curbs or equivalent barriers.
- (B) An equivalent barrier must be at least six inches in height and anchored sufficiently to prevent movement. Examples of alternatives are listed below:
 - (1) Equivalent barriers:
 - (a) Asphalt curbs.
 - (b) Railroad ties (anchored).
 - (c) Rock or stone curbs (anchored).
 - (d) Bollards located with a distance between each not to exceed four feet six inches measured from the outside surface of the bollard.
 - (e) Wheelstops (anchored).

(Ord. 97040, passed 11-24-97; Ord. 2005-13, passed 4-11-05)

Sec. 15-8-14. Alternative compliance.

- (A) The Director of Planning may accept alternative designs which prove to be as good or better than strict compliance with the basic landscape requirements.
- (B) Alternative proposals should be clearly identified on the landscape plans and the Building Permit application should include a letter outlining the alternative proposal. (See Exhibit C.) Review of the alternative proposal will be in conjunction with the Building Permit review.
- (C) To establish some guideline equivalents for the major landscape requirements listed in §§ 15-8-6 through 15-8-10, a list of alternative equivalent ratings are found below. These ratings assign relative values to the landscape elements of a design and should be used when formulating alternative proposals. Each basic requirement which cannot be achieved is assigned a negative point value and may be compensated for with positive equivalents shown in the compensation list. An example using this concept is provided in Figure 2-7.
- (D) These ratings are intended to provide guidance for proposing alternatives to strict compliance for unusual site specific conditions. However, other proposed equivalents may be accepted based on extremely unusual conditions, if approved by the Director of Planning.

*ALTERNATIVE COMPLIANCE EQUIVALENT RATINGS
Deficiencies*

The following information should be used to formulate alternative proposals when a site design cannot conform to the basic landscape requirements as described in § 15-8-6:

Landscape Area as a Percent of Street Yard	Negative Points
<5%	- 12
5%	- 10
6%	- 8
7%	- 6
8%	- 4
9%	- 2
10%	- 0

Landscape Area for Each 12 Parking Spaces	Negative Points
<3 square feet	- 6
3 square feet	- 3
4 square feet	- 0

Landscape Islands, Medians Peninsula Placement	Negative Points
Within 150 feet of each space	- 6
Within 125 feet of each space	- 3
Within 100 feet of each space	- 0

Trees Installed in Parking Landscape Areas	Negative Points

Within 150 feet of each space	- 6
Within 125 feet of each space	- 3
Within 100 feet of each space	- 0

Alternative Compliance Equivalent Ratings		
Trees		Positive Points
Percent of Installed Street Yard Trees (all must be from) Preferred Plant List (see Exhibit A)		3" or greater caliper
10%		2 pts.
20%		4 pts.
30%		6 pts.
40%		8 pts.
50% and greater		10 pts.
Buffer		1 pt.
Buffer Increased Above Minimum		2 pts.
10%		3 pts.
20%		4 pts.
30%		5 pts.
40%		
50%		
Special Landscape Features		
**Arbors, gazebos or shade seating areas for public benefit		+10
*Approved rain water storage and irrigation distribution systems		+10
Native Plant Credit		+10
*All native plant materials		

(Ord. 97040, passed 11-24-97; Ord. 98027, passed 12-28-98; Ord. 2005-13, passed 4-11-05)

Sec. 15-8-15. Screening standards.

A screening device is required between all R-1/R-2 residential land use/zoning and all types of multi-family (R-3 and above), commercial and industrial land use/zoning. Screening is also required between R-1/R-2 residential land use/zoning and all mobile home zoning land use/zoning.

(Ord. 2006-10, passed 4-10-06)

Sec. 15-8-16. General.

When screening is required, the installation and maintenance thereafter of a visual screen shall be provided consisting of a solid material and/or masonry fence or wall at least six feet in height which cannot be seen through.

(Ord. 97040, passed 11-24-97; Ord. 2005-13, passed 4-11-05; Ord. 2006-10, passed 4-10-06)

Sec. 15-8-17. Certificate of occupancy.

Landscaping. required in this section must be in place prior to obtaining a Certificate of Occupancy.

(Ord. 97040, passed 11-24-97; Ord. 2005-13, passed 4-11-05)

Sec. 15-8-18. Violations; penalties.

- (A) It shall be unlawful to construct, reconstruct, remove or relocate any landscaped area or other appurtenance in violation of the provisions of this article; and proper city officials, or their duly authorized representatives, in addition to other remedies, may institute any appropriate action or proceedings to prevent such unlawful construction, reconstruction, removal or relocation, to restrain, correct or abate such violations, to prevent any illegal act, conduct business or maintenance in and about such premises. Each day such violation continues shall constitute a separate violation.
- (B) Any person violating any provision of this article shall be guilty of a misdemeanor, and each shall be deemed guilty of a separate offense for each day or portion thereof during which any violation hereof is committed, continued or permitted, and upon conviction any such violation shall be punishable by a fine not to exceed \$500.00.

(Ord. 97040, passed 11-24-97; Ord. 2005-13, passed 4-11-05)

EXHIBIT A. PREFERRED PLANT LIST

Other plants may be used if approved by the city. This list is a guide and is not meant to be exclusive. Any other native or well adapted plant may be used if drawings are sealed by a registered Texas Landscape Architect.

Evergreen Trees	Height	Features (N = Native)
Arizona Cypress <i>Cupressus arizonica</i>	30'—75'	good heat and drought tolerance, aromatic foliage
Cherry Laurel <i>Prunus caroliniana</i>	25'—30'	N, screening plant, wildlife food
Deodar Cedar <i>Cedrus deodara</i>	40'—50'	fine texture, needs drainage
Live Oak <i>Quercus virginiana</i>	50'—60'	N, oak wilt susceptible
Mountain Laurel <i>Sophora secundiflora</i>	15'—25'	N, fragrant purple spring blossoms, small tree, large shrub
Texas Madrone <i>Arbutus texana</i>	25'—30'	N, distinctive, attractive bark, difficult to propagate and transplant
Yaupon Holly <i>Ilex vomitoria</i>	15'—20'	N, red berries in winter, small tree, large shrub

Deciduous Trees	Height	Features (N = Native)
American Elm <i>Ulmus americana</i>	60'—80'	N, vase-shaped canopy, susceptible to Dutch Elm disease
Bald Cypress <i>Taxodium distichum</i>	60'—70'	N, fine texture, rust fall color
Bradford Pear <i>Pyrus calleryana 'Bradford'</i>	30'—40'	showing white spring flowers

Bur Oak <i>Quercus muehlenbergii</i>	60'—100'	N, large fringed acorn, majestic, adaptable tree
Cedar Elm <i>Ulmus crassifolia</i>	50'—60'	N, fall color, small leaves
Chinese Pistache <i>Pistacia chinensis</i>	30'—40'	brilliant fall color, very adaptable
Chinquapin Oak <i>Quercus Muhlenbergii</i>	40'—60'	N, tall, slender form, dark glossy lush foliage
Crape Myrtle* <i>Lagerstroemia indica</i>	25'—30'	summer flowers, many varieties
Desert Willow <i>Chilopsis linearis</i>	15'—25'	N, orchid-like blooms, not a true willow
Drake Elm <i>Ulmus parvifolia</i> 'Drake'	20'—30'	nearly evergreen, drought tolerant
Fragrant Ash <i>Fraxinus cuspidata</i>	10'—12'	N, fragrant white flowers in late spring
Golden Rain Tree <i>Koelreuteria bipinnata</i> * and <i>K. paniculata</i>	20'—30'	yellow spring blooms, drought tolerant
Honey Mesquite <i>Prosopis glandulosa</i>	25'—30'	N, drought tolerant, wood valued for smoking meat
Mexican Plumb <i>Prunus mexicana</i>	15'—25'	N, white spring blossoms, wildlife food
Orchid Tree <i>Bauhinia</i> spp.	6'—12'	N, showy white blossoms, small understory or patio tree
Pecan <i>Carya illinoensis</i>	60'—80'	N, shade tree, nut producing
Shumard Oak <i>Quercus shumardii</i>	50'—75'	N, fast growing, good fall red foliage coloration, very tolerant of limestone soils
Texas Ash <i>Fraxinus texensis</i>	40'—50'	N, fast growing, shade tree, exceptional fall foliage coloration
Texas Persimmon <i>Diospyros texana</i>	15'—20'	N, wildlife food, multi-trunk
Texas Redbud <i>Cercis Canadensis</i> var. 'Texensis'	20'—25'	N, early pink-blossoms, drought tolerant
Texas Red Oak <i>Quercus texana</i>	30'—40'	N, white patches on bark, fall color
Vitex, Lilac Tree <i>Vitex Agnus-castus</i>	15'—20'	late spring lavender blossoms, small tree
Western Soapberry <i>Sapindus Drummondii</i>	30'—40'	N, showy winter fruit, yellow fall color
*susceptible to severe freeze		

Evergreen Shrubs	Sun	Shade	Features (N = Native)
Agarita <i>Berberis trifoliolata</i>	o		N, prickly leaves, bright red berries
Barbados Cherry* <i>Malpighia glabra</i>	o	o	N, pale pink flowers, berries attract wildlife

Burford Holly <i>Ilex cornuta</i> 'Burfordii'	o	o	glossy dark green foliage, red fruit
Dwarf Burford Holly <i>Ilex cornuta</i> 'Burfordii nana'	o	o	glossy leaves, berries not prominent
Dwarf Chinese Holly <i>Ilex cornuta</i> 'Rotunda nana'	o	o	spiny foliage, no berries
Dwarf Yaupon Holly <i>Ilex vomitoria</i> 'Nana'	o	o	low mound-like shrub, no berries
Elaeagnus <i>Elaeagnus pungens</i>	o	o	silver foliage, fragrant white fall flowers
Mountain Laurel <i>Sophora secundiflora</i>	o	o	N, showy fragrant purple flower, large shrub
Nandina <i>Nandina domestica</i>	o	o	red berries, red fall, winter color
Oleander* <i>Nerium oleander</i>	o		summer flowers, large shrub
Pampas Grass* <i>Cortaderia selloana</i>	o		large, clumping grass
Red Yucca <i>Hesperaloe parviflora</i>	o		N, coral flower spike, not a true yucca
Rosemary* <i>Rosmarinus officinalis</i>	o		aromatic leaves, 'Prostratus' cultivar
Shore Juniper <i>Juniperus conferta</i>	o		spreading, ground cover, blue-green
Texas Sage <i>Leucophyllum frutescens</i>	o		N, lavender flowers, gray or green foliage
Texas Sotol <i>Dasyliirion texanum</i>	o		N, long blade-like leaf with spines
Wax Myrtle <i>Myrica cerifera</i>	o	o	N, very adaptable, aromatic leaves, berries used for Bayberry fragrance

Semi-Evergreen Shrubs**	Sun	Shade	Features (N = Native)
Cast Iron Plant** <i>Aspidistra elatior</i>		o	broad strap shaped leaves to 2 inches height
Glossy Abelia <i>Abelia grandiflora</i>	o		small pink flowers, glossy leaves
Muhly Grass <i>Muhlenbergia lindheimeri</i>	o		N, looks like small pampas grass
Pineapple Guava* <i>Feijoa sellowiana</i>	o		exotic fragrant flowers
Pomegranate* <i>Punica granatum</i>	o	o	orange flowers, yellow fall flowers
Primrose Jasmine <i>Jasminum mesnyi</i>	o		yellow flowers, mounding form
* susceptible to severe freeze			
** influenced by severity or duration of winter			

Deciduous Shrubs	Sun	Shade	Features (N = Native)
Althaea Hibiscus syriacus	o		showy summer flowers
Butterfly Bush Buddleia Davidii	o		N, lavender/lilac flowers, small fuzzy leaves
Flame Acanthus Anisacanthus Wrightii	o	o	N, orange flowers attracts hummingbirds
Texas Lantana* Lantana horrida and L. camara	o		N, good summer color, many varieties
Trailing Lantana* Lantana montevidensis	o	o	N, lilac colored flowers, summer through fall
*susceptible to severe freeze			

Evergreen Vines & Groundcovers	Sun	Shade	Features (N = Native)
Asian Jasmine* Trachelospermum asiaticum	o	o	low vigorous ground-cover
Bigleaf Periwinkle Vinca major		o	loose ground-cover, blue flowers
Carolina Jessamine Gelsemium sempervirens	o	o	N, fragrant yellow flowers in spring
Coral Honeysuckle Lonicera sempervirens	o	o	N, coral flowers, red fruit, attract wildlife
Crossvine Bignonia capreolata	o	o	N, yellow/red flowers, clinging vine
Damianita Chrysactinia mexicana	o		N, yellow flowers, low growing to 12" height
English Ivy Hedera helix		o	clinging, vigorous, self-climbing vine
Fig Vine* Ficus pumila	o	o	clinging vine, fine texture
Lady Banks' Rose Rosa banksiae	o		yellow spring flowers, large cascading form
Big Blue Lilyturf Liriope muscari		o	purple spike flowers, clump-like foliage
Dwarf Periwinkle Vinca minor		o	blue flowers, ground-cover
Monkey Grass Ophiopogon japonicus		o	tufted grass-like ground-cover
Oregano Origanum vulgare	o	o	perennial, spreading herb
Stonecrop Sedum spp.	o	o	low, fast growing ground-cover
*susceptible to severe freeze			

Deciduous Vines & Groundcovers	Sun	Shade	Features (N = Native)
Bush Morning Glory Ipomoea leptophylla	o	o	N, forms 1-1/2'—3' mounds of foliage, lavender to purple flowers

Coral Vine Anigonon leptopus	o		pink flowers in summer and fall
Gregg Dalea* Dalea greggii	o	o	N, purple flowers in fall, ground-cover
Passion Vine* Passiflora incarnata	o	o	N, lavender flowers, edible fruit: Maypop
Trumpet Vine Campsis radicans	o	o	N, orange-scarlet flowers, invasive
Virginia Creeper* Parthenocissus quinquefolia	o	o	N, red fall color, clinging vine
*susceptible to severe freeze			

Flowering Perennials	Sun	Shade	Features (N = Native)
Silver Wormwood Artemisia ludoviciana	o		N, aromatic foliage, white fuzzy leaves
Black-eyed Susan Rudbeckia hirta	o	o	N, yellow dark-centered daisy, flowers May to September
Blackfoot Daisy Melampodium leucanthum	o		N, short white daisy flowers all summer, short lived
Butterfly Weed Asclepias tuberosa	o	o	N, orange/yellow flowers, attracts butterflies
Canna Lily Canna X generalis	o		banana-like foilage, blooms in summer
Cedar Sage Salvia roemeriana		o	N, red flowers, naturalizes
Cherry Sage Salvia greggii	o	o	N, red, pink, or white flowers
Cigar Plant Cuphea micropetala	o		orange-yellow fall flowers
Coreopsis Coreopsis lanceolata	o		N, yellow spring and fall flowers, clumping
Daylily Hemerocallis fulva	o		orange/yellow funnel-shaped flower
Fall Aster Symphyotrichum oblongifolium	o	o	N, blue/purple autumn flowers
Firebush* Hamelia patens	o		red-orange flowers, red fall color
Gayfeather Liatris spp.	o		N, purple flower spikes in autumn
Heartleaf Hibiscus Hibiscus cardiophyllus	o	o	N, red flowers all summer
Hymenoxys Hymenoxys scaposa	o		N, small yellow daisy, bitter smelling leaves
Maximilian Sunflower Helianthus maximiliana	o		N, yellow flower, late summer to fall
Mealy Blue Sage Salvia farinacea	o		N, blue flower spikes, spring and summer

Mexican Bush Sage Salvia leucantha	o		tall purple flower spikes
Mexican Heather* Cuphea hyssopifolia	o		tiny purple, pink or white flowers
Mexican Marigold Mint Tagetes lucida	o	o	yellow fall flowers, anise flavored foliage
Mexican Oregano Lippia graveolens	o		lavender/pink flowers, aromatic
Oxeye Daisy Chrysanthemum leucanthemum	o		white early summer flowers, yellow center
Peruvian Verbena* Verbena peruviana	o	o	pink flowers in summer, low growing
Pink Skullcap Scutellaria suffrutescens	o	o	pink flowers in summer, low growing
Plumbago* Plumbago auriculata	o	o	low growing, blue flowers
Purple Coneflower Echinacea purpurea	o	o	N, purple daisy-like flowers
Rose Mallow Pavonia lasiopetala	o	o	N, pink hibiscus-like flowers
Scarlet Sage Salvia coccinea	o	o	N, red, pink or white flowers, spring to fall
Spiderwort Tradescantia x Andersoniana		o	N, purple-blue flowers, informal ground cover
Turk's Cap Malvaviscus arboreus 'Drummondii'	o	o	N, red flowers and fruit, colonizing
White Mistflower Eupatorium Wrightii	o	o	N, white autumn flowers, attracts butterflies
Wild Petunia Ruellia nudiflora		o	N, purple flowers from March to December
Zexmenia Wedelia hispida	o	o	N, orange/yellow flowers, May to November
*susceptible to severe freeze			

Turf & Low Grasses	Sun	Shade	Features (N = Native)
Bermuda Cynodon dactylon	o		seed or hybrid sod
Blue Grama Bouteloua gracilis	o		N, seed, fine-leaf tufted grass, good meadow grass, not for mowed lawns
Buffalograss Buchloe dactyloides	o		N, many seed varieties, sod available in '609' and Prairie hybrids
Little Bluestem Schizachyrium scoparium	o		N, seed, blue-green, fine texture, not for mowed lawns

(Ord. 2014-45, passed 8-11-2014)

EXHIBIT B. LANDSCAPE/IRRIGATION NOTES

Created: 2024-05-29 11:27:59 [EST]

(Supp. No. 54)

SITE DEVELOPMENT PERMIT - IRRIGATION NOTES

Automatic irrigation systems shall comply with the following guidelines. These guidelines (No. 1—No. 7) shall be noted on the Site Development Permit and shall be implemented as part of the landscape inspection.

1. Adjustable flow controls shall be required on circuit remote control valves and pressure regulation component(s) shall be required where static pressure exceeds manufacturer's recommended operating range.
2. Valve and circuits shall be separated based on water use, so that turf areas can be watered separately from shrub and ground cover areas.
3. Sprinkler heads shall have matched precipitation rates within each control valve circuit.
4. Serviceable check valves shall be required where elevation differential may cause low head drainage, adjacent to paving areas.
5. Sprinkler head spacing shall be designed for head-to-head coverage or heads shall be spaced as per manufacturer's recommendations and adjusted for prevailing winds. The system shall be designed for minimum run-off and minimum over-spray onto non-irrigated areas, (i.e. paving and structures).
6. All automatic irrigation systems shall be equipped with a controller capable of dual or multiple programming. Controllers shall have multiple cycle start capacity and a flexible calendar program, including the capability of being set to water every five days. All automatic irrigation systems shall be equipped with a rain sensor shut-off device.
7. Irrigation construction plans shall include a water budget. A laminated copy of the water budget shall be permanently installed inside the irrigation controller door. Water budget shall include:
 - a. Estimated monthly water use (in gallons per application) and the area (in square feet) irrigated.
 - b. Precipitation rates for each valve circuit.
 - c. Monthly irrigation schedule for the plant establishment period (first three months) and recommended yearly watering schedule, including seasonal adjustments.
 - d. Location of emergency irrigation system shut-off valve.

EXHIBIT C. SAMPLE ALTERNATIVE COMPLIANCE LETTER

PROJECT NAME:

PROJECT ADDRESS:

DATE:

NAME OF OWNER:

ADDRESS OF OWNER:

ADDRESS LETTER TO:

NAME OF DIRECTOR:

;hg;Director of Planning
City of Kingsville
200 E. Kleberg
Kingsville, TX 78363

INCLUDE IN THE LETTER:

The body of the letter should state specifically in what way the project will not comply with the Landscaping Regulations and explain in detail how the alternative compliance proposal is "as good or better" than strict compliance as required.

The letter should also include the following:

1. The size, type and spacing of plant materials installed as part of the alternative compliance proposal.
2. The ordinance section numbers that the project is not complying with.
3. The contact person and the phone number where they can be reached during working hours.
4. The signature of the owner and agent.

(Ord. 2005-13, passed 4-11-05)

EXHIBIT D. FIGURES

Figure 2-1

NEW ADDITION

More than 1,000 Sq. Ft. but does not affect Street Yard

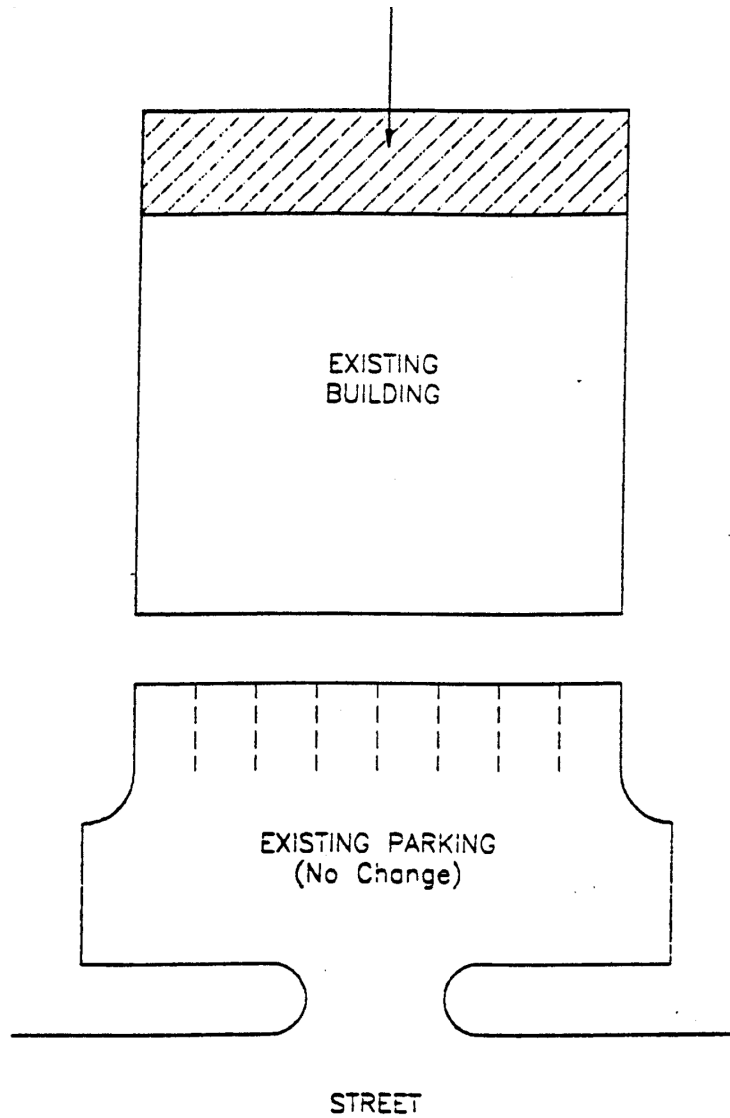

Exempt Projects

Figure 2-1
NEW ADDITION

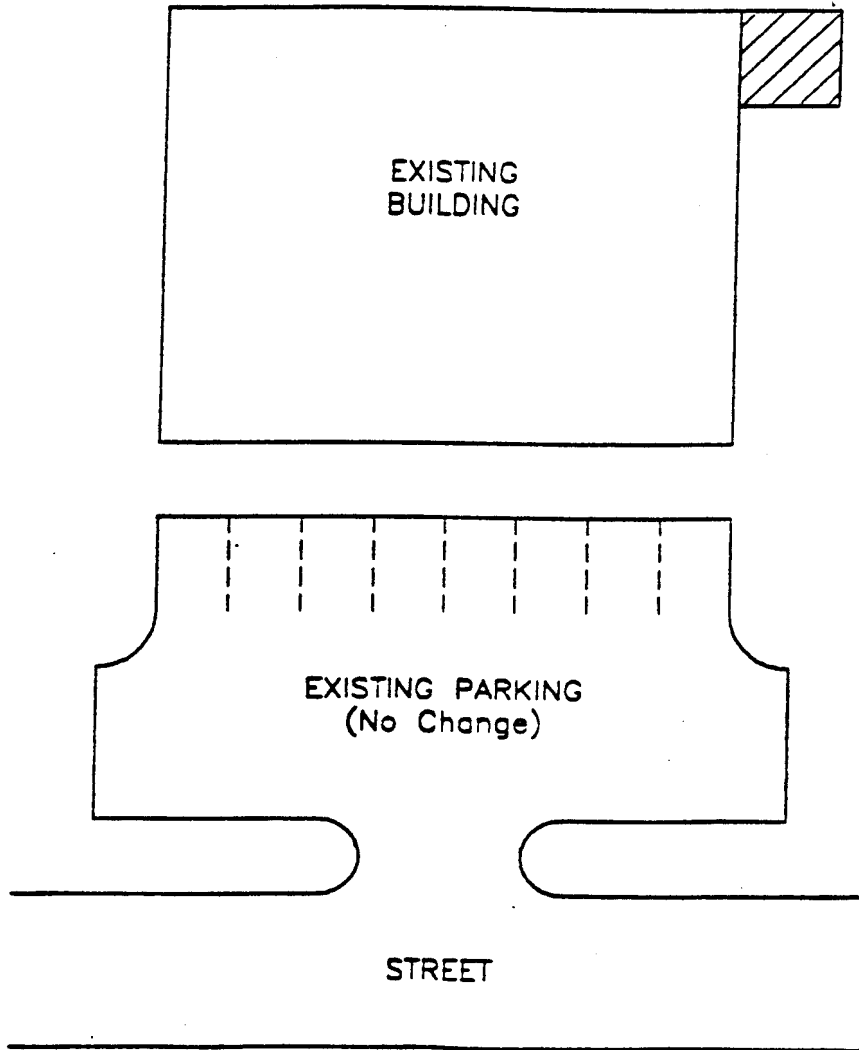

Exempt Projects (Continued)

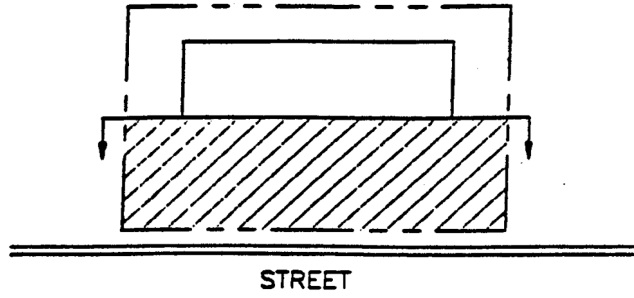

TYPICAL
BUILDING

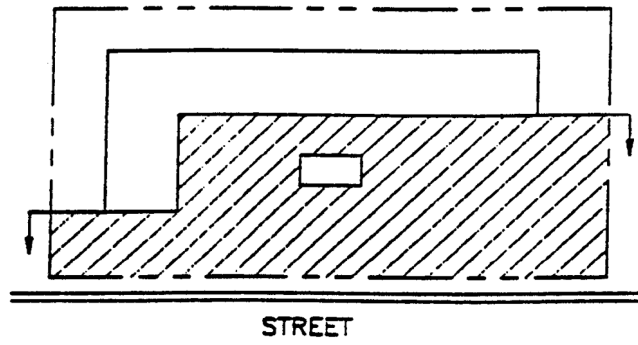

ISOLATED
BUILDING

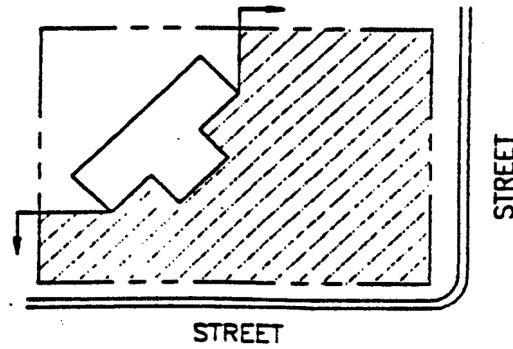

CORNER
LOT

Street Yard Configurations

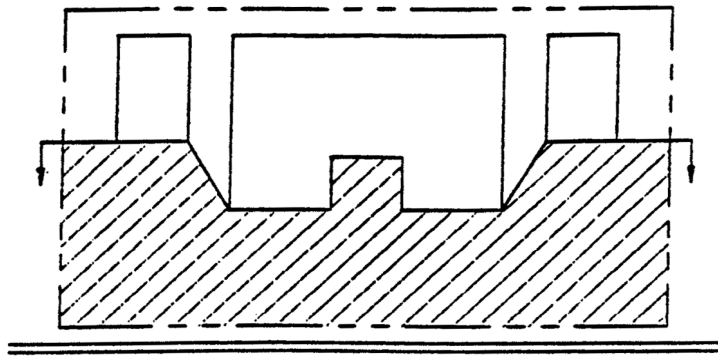

STREET
RECESSED WALLS - FRONT BUILDING

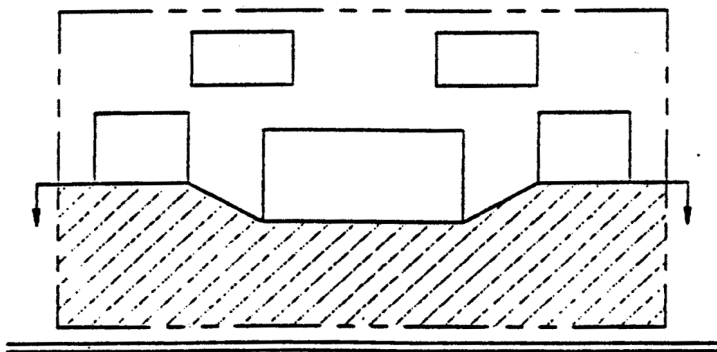

STREET
RECESSED BUILDING

Street Yard Configurations (Continued)

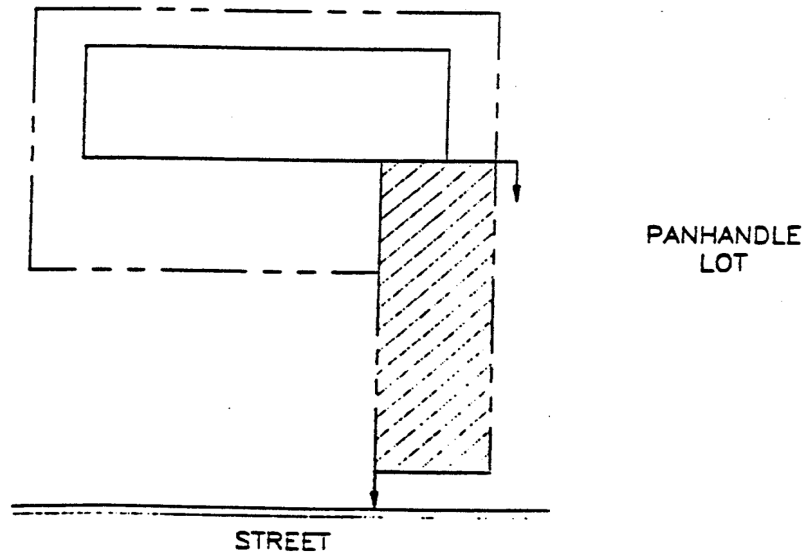
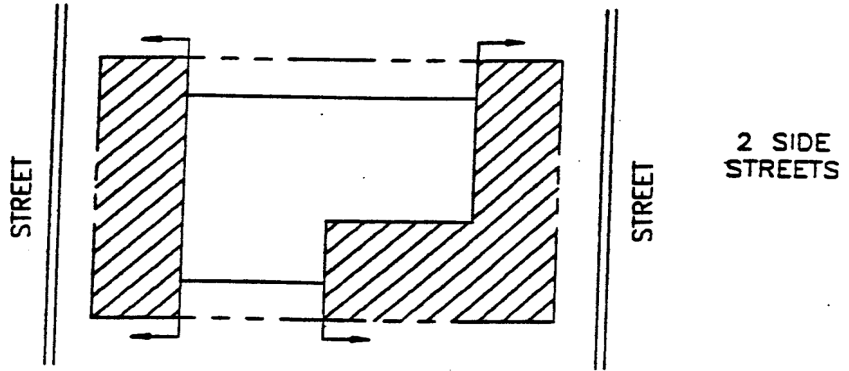

Street Yard Configurations (Continued)

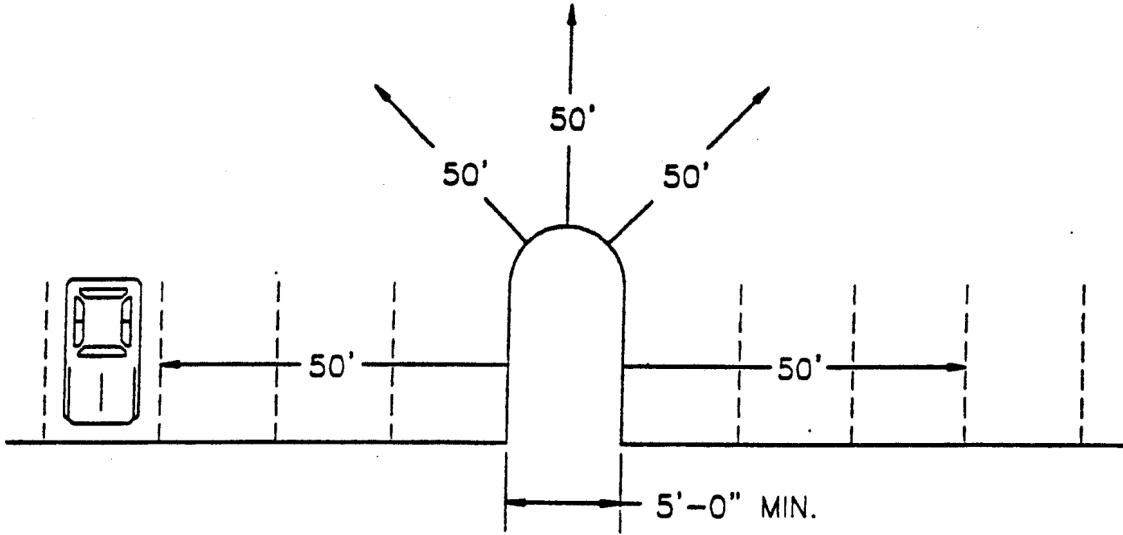

50 FOOT REQUIREMENT

PENINSULAS

Peninsula Placement (50 Foot Requirement)

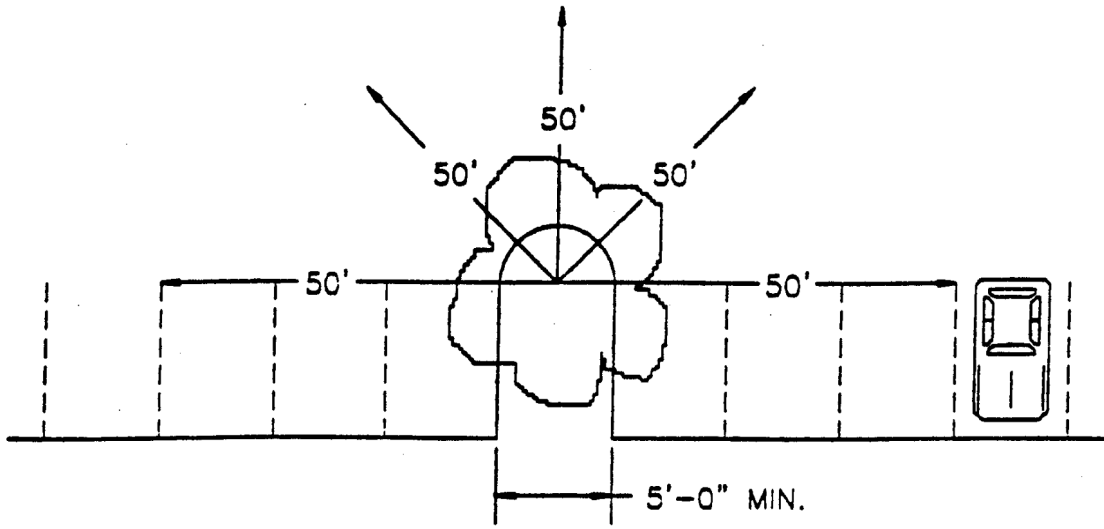

50 FOOT REQUIREMENT

TREES

Tree Placement (50 Foot Requirement)

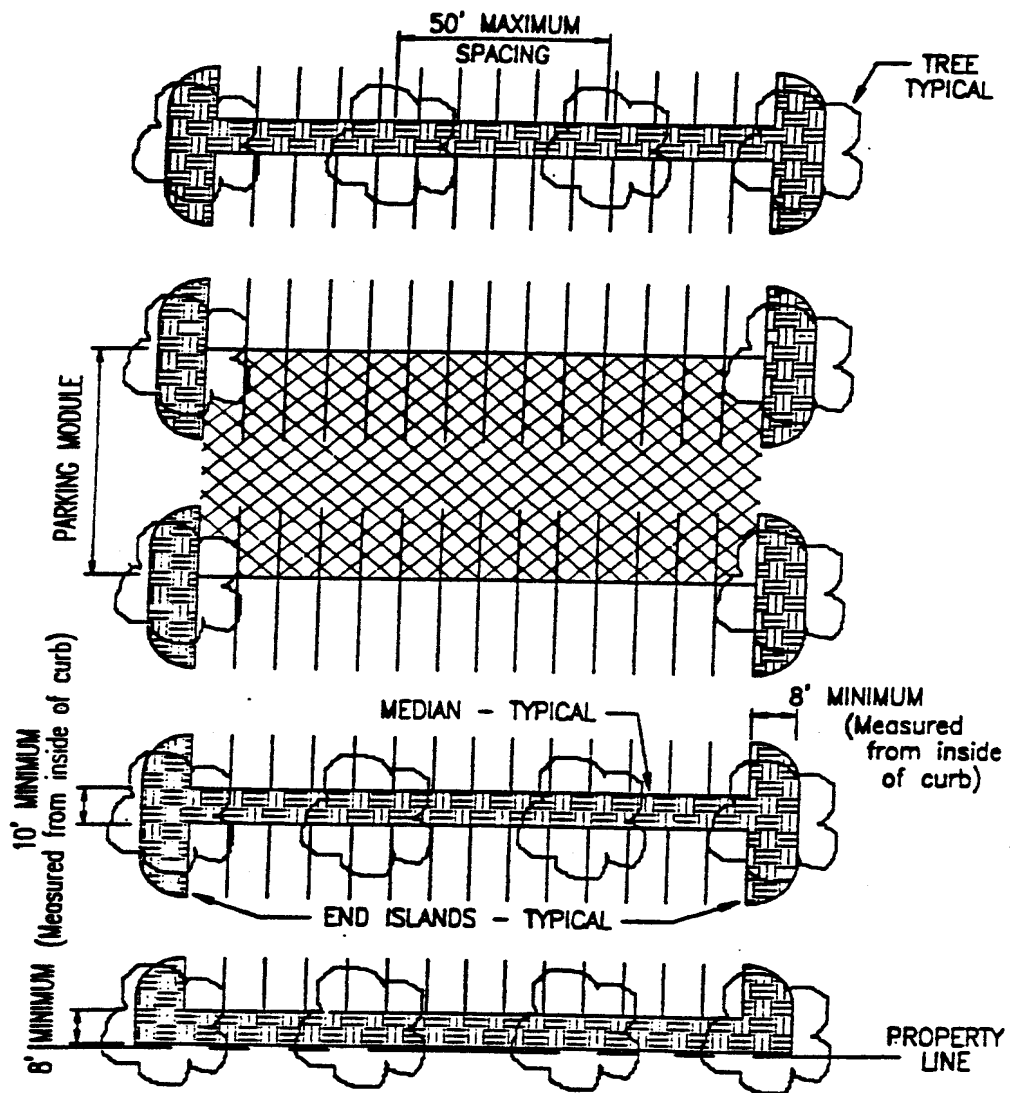

Layout for Large Parking Lots

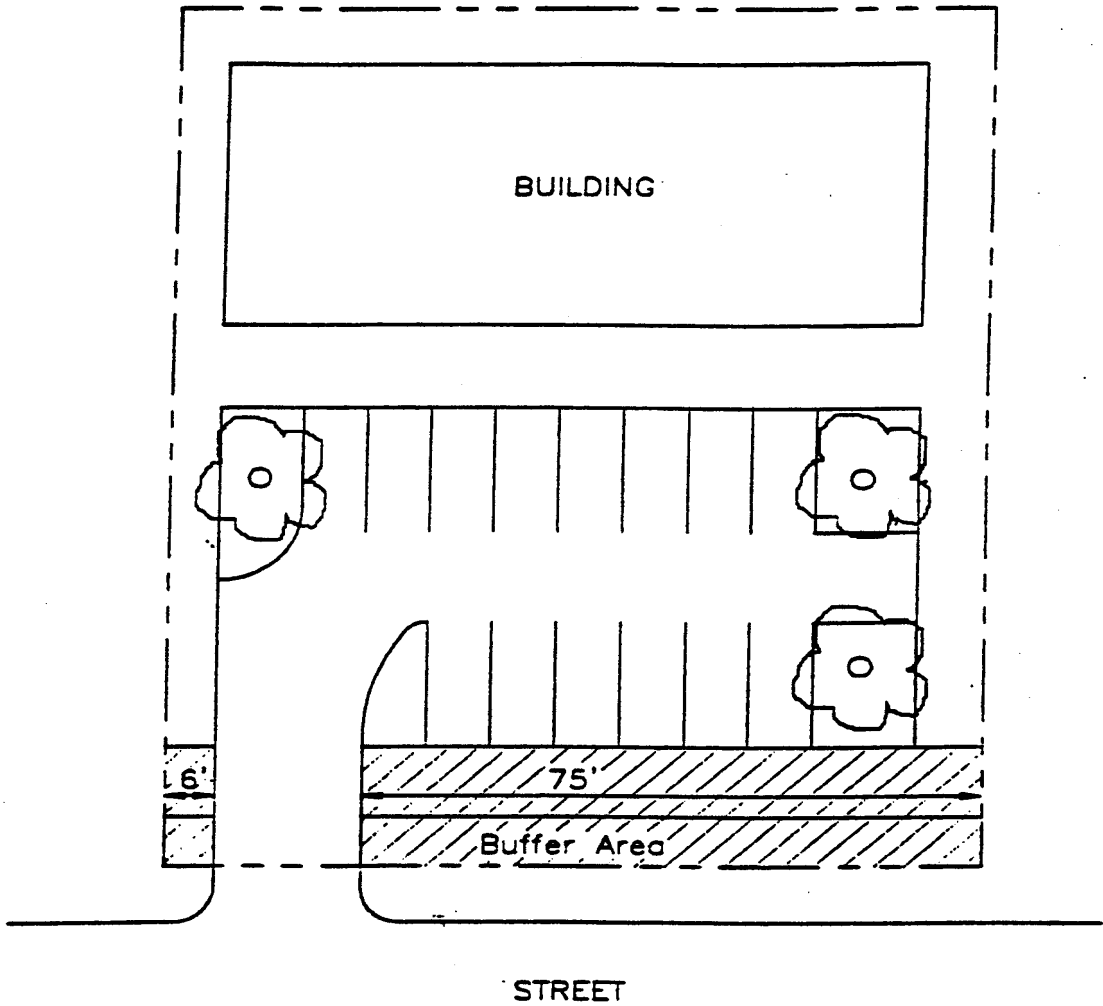

BUFFER POINTS REQUIRED (as illustrated) = 81

Example of Buffer Area Measurement

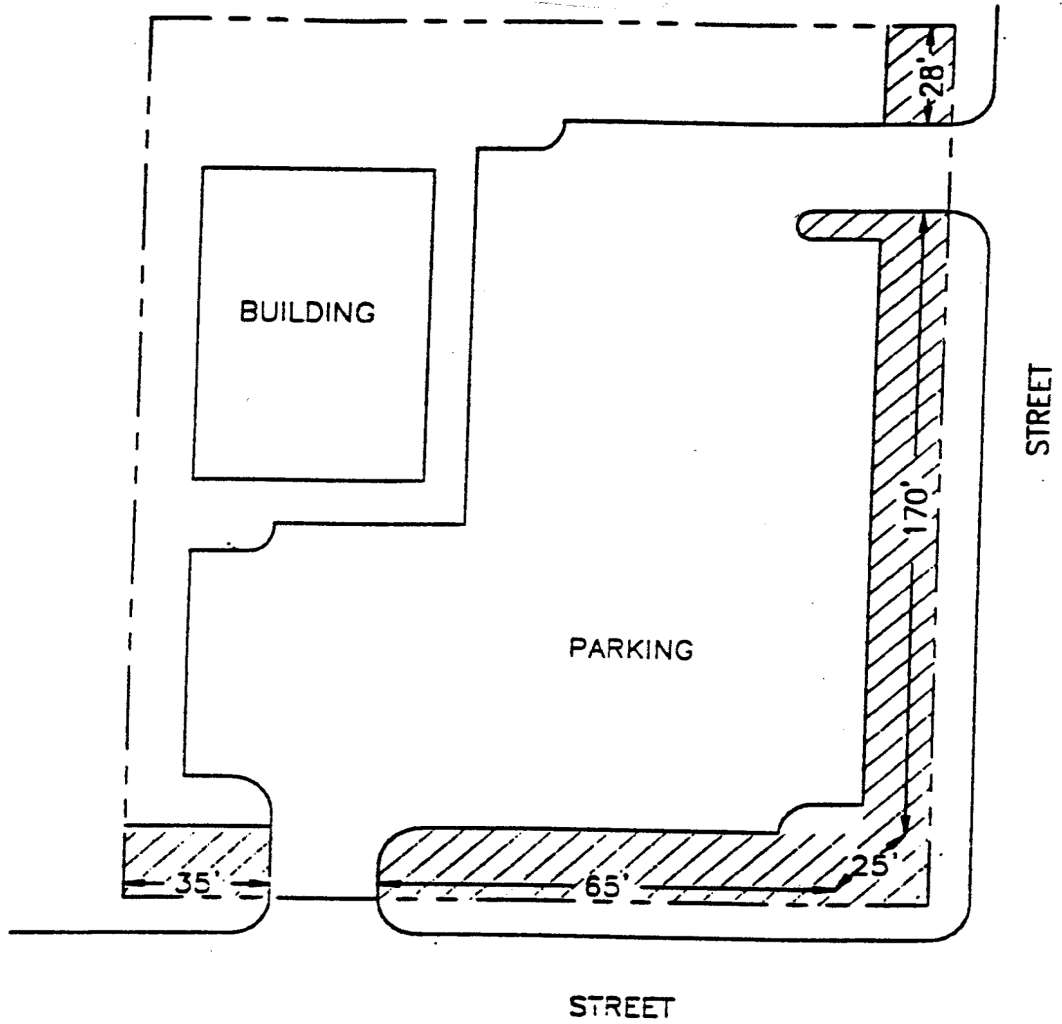

BUFFER POINTS REQUIRED (as illustrated) = 323 Ft.

Example of Buffer Area Measurement (Continued)

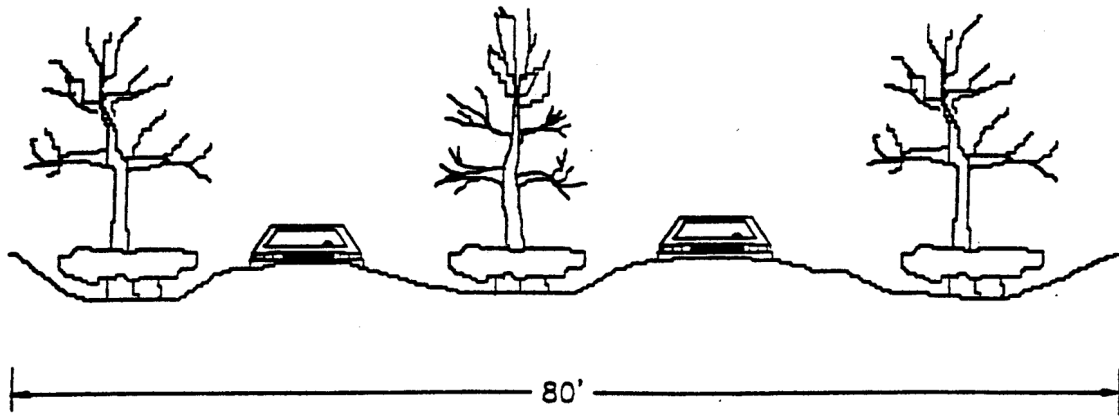

BUFFER PLANTING		
POINTS REQUIRED	ELEMENTS	POINTS ILLUSTRATED
80' X 1 pt./ft. = 80 pts.	0 Shrubs	0 Shrubs = 36 pts.
	0 Trees	0 Trees = 27 pts.
	0 Berms	0 Berms = 25 pts.
		<u>88 pts.</u>

Example of Buffer Planting

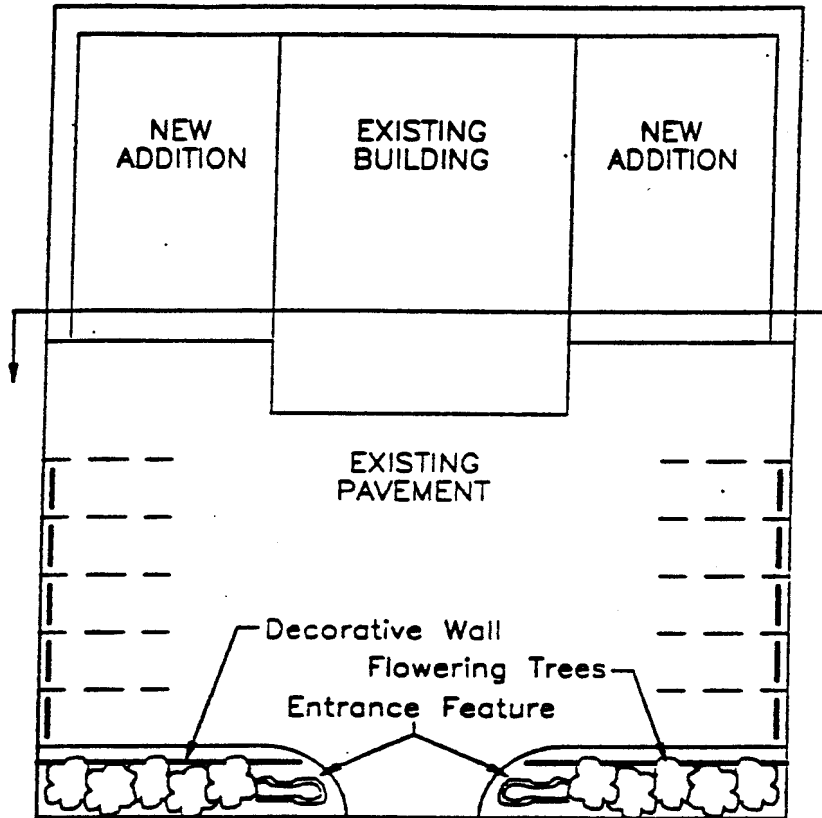

- ALTERNATIVE COMPENSATION**
- o Buffer Increase
 - o Native Trees & Shrubs
 - o Entrance Color Planting

Alternative Compliance — Example Solution

Figure 2-7
Alternative Compliance
Landscape Calculation List

This calculation list should be substituted for the General Landscape Calculation List on all landscape plans that are part of an Alternative Compliance Proposal.

		Required	Provided
1.	Total Site Area (Sq. Ft.)		
2.	Street Yard Area (Sq. Ft.)		
3.	Lanscaped Street Yard Area (Sq. Ft.)		
4.	Street Yard Trees (No.)		
5.	Street Yard Parking Islands/Peninsula (Sq. Ft.)		
6.	Non-Street Yard Parking Islands/Peninsula (Sq. Ft.)	N/A	N/A
7.	Buffer Points		
8.	Code Sections for which Alternative Compliance is Requested:		
	A.		
	B.		
	C.		
9.	Alternative Compliance Points		

N/A = Not applicable

(Ord. 97040, passed 11-24-97; Ord. 2005-13, passed 4-11-05)

First question...do I need an inspection?

Short answer: Probably...please see the list of projects below that require an inspection:

Types of inspections. Due to the varying nature of construction, the types of inspections vary. The most common inspections are listed below and **should not** be construed as the only required inspections. If there are any questions, please feel free to reach out to the City of Kingsville development services.

Building

1. Footing (piers)
2. Foundation (pre pour)
3. Framing (including exterior sheathing before it is covered by a weather barrier.)
4. Masonry
5. Insulation
6. Fire Rated Assembly (including, but not limited, to drywall at required separations)
7. Building Final
8. Sidewalk/Driveway (city sidewalk and approach in easement)
9. Certificate of Occupancy

Mechanical

1. Mechanical Rough
2. Mechanical Final
3. Energy Final (duct tightness, where applicable, and blower door tests)

Electrical

1. Temp power
2. Underground
3. Electrical Rough
4. Meter loop (permanent power)
5. Electrical Final

Fire

1. Fire Life Safety Overall Annual

Plumbing

1. Underground Plumbing
2. Sewer Connection
3. Waterline
4. CSI - Water line
5. Plumbing top out
6. Plumbing Final

Fuel Gas

1. Underground
2. Rough in

3. Final

NOTE: Work shall not be performed beyond the point indicated in each successive inspection without first obtaining the approval of the building official. The building official, upon notification, shall make the requested inspections and shall either indicate the portion of the construction that is “satisfactory as completed,” or shall notify the permit holder or an agent of the permit holder wherein the same “fails to comply.” Any portions that do not comply shall be corrected and such portion shall not be covered or concealed until authorized by the building official.

To schedule an inspection, call the City of Kingsville Planning & Development Services Department at
(361) 595-8019/8055



Fee of \$25.00 due upon submission. An additional fee per floor charged for multi-story buildings

Certificate of Occupancy Application

Project Information	
Proposed Business Name: _____	Proposed Business Use: _____
Project Address: _____	
Total Parking Spaces: _____	Legal Description: _____
Total Occupancy of Building: _____	Sq. Ft.: _____ Zoning District: _____

Owner Information	
Company Name: _____	Contact Person: _____
Street Address: _____	
Email: _____	
Phone: _____	Fax: _____ Mobile: _____

Tenant Information	
Company Name: _____	Contact Person: _____
Street Address: _____	
Email: _____	
Phone: _____	Fax: _____ Mobile: _____

Does your business involve the storage, sale or use of the following? (Check all that apply)

- Painting with flammables
- Combustible Fibers
- Cellulose Nitrate Film
- Compressed Gas
- Liquid Propane Gas
- Vehicle Repair Garage
- Welding or Cutting
- Dry Cleaning Solvents
- Dust producing process
- Explosives/Ammunition
- Recycling Waste
- Magnesium
- Vehicles in Building
- Woodworking
- Flammable/combustible liquids (10 gallons or more)
- Floor drains in building
- Food and/or beverage processing, storage or sales
- Food products
- High piled stock (over 12' in height)
- Poisonous or hazardous chemicals/acids
- X-ray Development
- Alcohol
- Smoking
- Fireworks

****Provide chemical data sheets to the Building Inspection Department listing the maximum quantity of all hazardous materials.** List any material discharged into the drainage system, ground, or atmosphere: _____**

It shall be unlawful to use or occupy or permit the use or occupancy of any building or premises created, erected, changed, converted or altered or enlarged in its use or structure until a Certificate of Occupancy shall have been issued by the administrative official. A permit becomes null and void if work or construction authorized is not commenced within 180 days, or if construction or work is suspended or abandoned for a period of 180 days at any time after work is commenced.

I hereby certify that I have read and examined this application and know the same to be true and correct. All provisions of laws and ordinances governing this type of work will be complied with whether specified or not. The granting of a permit does not presume to give authority to violate or cancel the provisions of any other state or local law regulating construction or the performance of construction.

Signature of Applicant: _____

Date: _____

Building Official	Approved By	Date	Comments
Fire Department			
Health Department (as req'd)			
Application Approved: _____		Date Issued: _____	
Certificate of Occupancy Verified by Planning Director: _____		Date Issued: _____	

City of Kingsville Ordinances of Interest:**Building Code:**

https://library.municode.com/tx/kingsville/codes/code_of_ordinances?nodeId=PT2COOR_CHXVLAUS_ART1BURE_BUCO

Plumbing Code:

https://library.municode.com/tx/kingsville/codes/code_of_ordinances?nodeId=PT2COOR_CHXVLAUS_ART1BURE_PLCO

Fuel Gas Code:

https://library.municode.com/tx/kingsville/codes/code_of_ordinances?nodeId=PT2COOR_CHXVLAUS_ART1BURE_FUGACO

Electrical Code:

https://library.municode.com/tx/kingsville/codes/code_of_ordinances?nodeId=PT2COOR_CHXVLAUS_ART1BURE_ELCO

Mechanical Code:

https://library.municode.com/tx/kingsville/codes/code_of_ordinances?nodeId=PT2COOR_CHXVLAUS_ART1BURE_MECO

Swimming Pool Code:

https://library.municode.com/tx/kingsville/codes/code_of_ordinances?nodeId=PT2COOR_CHXVLAUS_ART1BURE_SWPOCO

Residential Code for 1 and 2-Family Dwellings:

https://library.municode.com/tx/kingsville/codes/code_of_ordinances?nodeId=PT2COOR_CHXVLAUS_ART1BURE_RECOOMIDW

Permit and License Provisions:

https://library.municode.com/tx/kingsville/codes/code_of_ordinances?nodeId=PT2COOR_CHXVLAUS_ART2MOHOMOHOPA_PELIPR

Energy Conservation Code:

https://library.municode.com/tx/kingsville/codes/code_of_ordinances?nodeId=PT2COOR_CHXVLAUS_ART1BURE_ENCOCO

Existing Building Code:

https://library.municode.com/tx/kingsville/codes/code_of_ordinances?nodeId=PT2COOR_CHXVLAUS_ART1BURE_EXBUCO

Subdivisions:

https://library.municode.com/tx/kingsville/codes/code_of_ordinances?nodeId=PT2COOR_CHXVLAUS_ART3SU

Platting Procedures:

https://library.municode.com/tx/kingsville/codes/code_of_ordinances?nodeId=PT2COOR_CHXVLAUS_ART3SU_PLPR

Design Standards:

https://library.municode.com/tx/kingsville/codes/code_of_ordinances?nodeId=PT2COOR_CHXVLAUS_ART3SU_DEST

Drainage:

https://library.municode.com/tx/kingsville/codes/code_of_ordinances?nodeId=PT2COOR_CHXVLAUS_ART3SU_DR

Zoning:

https://library.municode.com/tx/kingsville/codes/code_of_ordinances?nodeId=PT2COOR_CHXVLAUS_ART6ZO

Sign Regulations:

https://library.municode.com/tx/kingsville/codes/code_of_ordinances?nodeId=PT2COOR_CHXVLAUS_ART6ZO_SIRE

Appendix A – Land Use Categories:

https://library.municode.com/tx/kingsville/codes/code_of_ordinances?nodeId=PT2COOR_CHXVLAUS_ART6ZO_APXALAUSSCA

Appendix B- Space Requirements:

https://library.municode.com/tx/kingsville/codes/code_of_ordinances?nodeId=PT2COOR_CHXVLAUS_ART6ZO_APXBSPRE

Points of Contact

<u>Position</u>	<u>Name</u>	<u>Email address</u>	<u>Phone #</u>
Permit Clerk	Mrs. Theresa Cavazos	tcavazos@cityofkingsville.com	361-595-8019
Senior Planner	Mr. Kobby Agyekum	kagyekum@cityofkingsville.com	361-221-6754
Building Official	Mrs. Belinda Tarver	btarver@cityofkingsville.com	361-595-8020
Building Inspector	Vacant	<u>TBD</u>	361-595-8022
City Engineer	Mr. Rutilio Mora	rmora@cityofkingsville.com	361-595-8004
Health Director	Mr. Emilio Garcia	egarcia@cityofkingsville.com	361-592-3324
Public Works Director	Mr. Bill Donnel	wdonnell@cityofkingsville.com	361-595-8051
Fire Marshal	Mr. Steve Palacios	spalacios@cityofkingsville.com	361-592-6445
Downtown Manager	Mrs. Alicia Tijerina Mr.	atijerina@cityofkingsville.com	361-592-8516
Chamber of Commerce	Manny Salazar	manny@kingsville.org	361-592-6438